

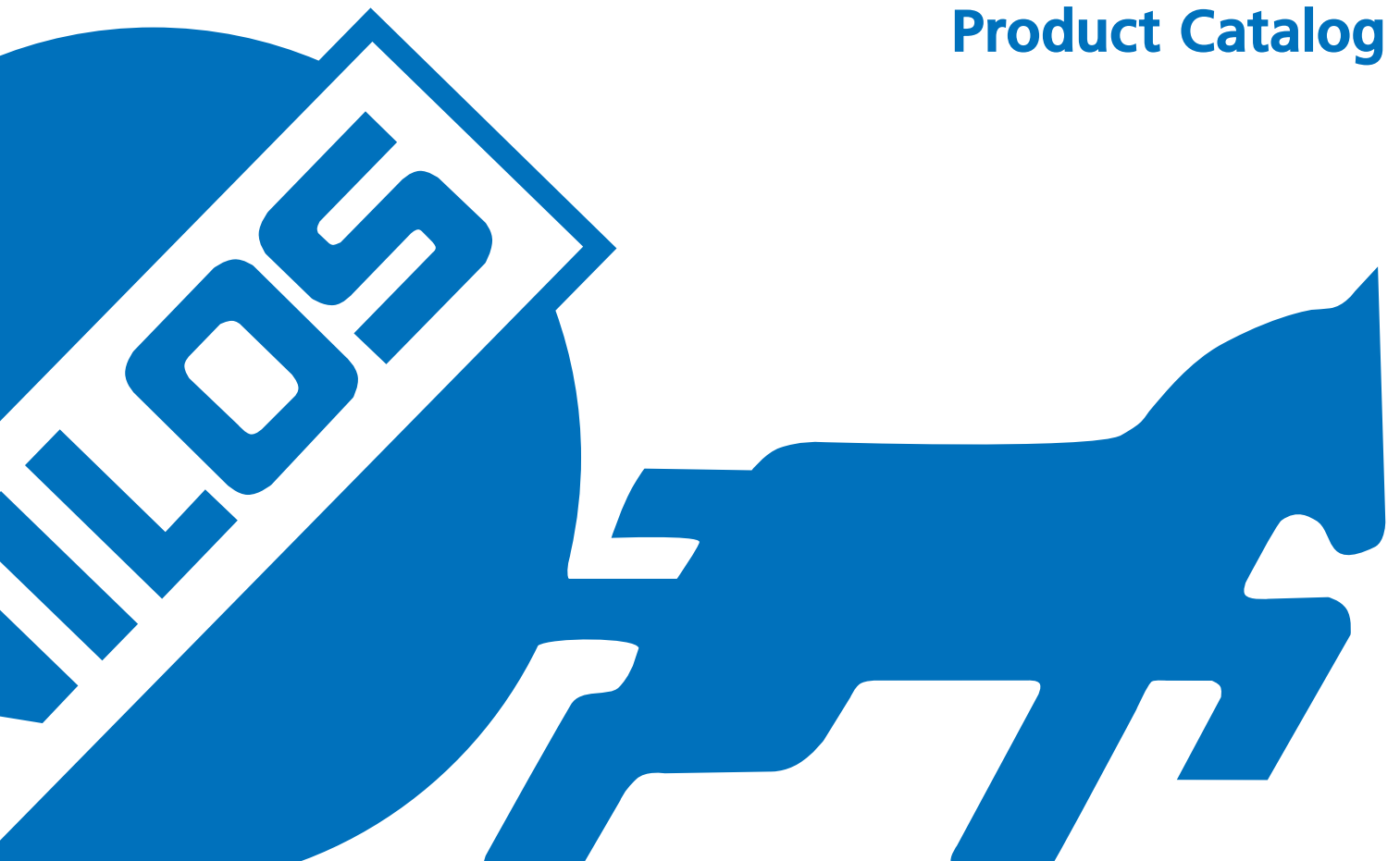

NILOS

Product Catalog





NILOS

Contents

4 - 5 ZILLER Holding

Industrial Rubber

- 8 - 9 Hot vulcanizing Splicing kits for steel and fabric belts
 - 10 - 11 Hot vulcanizing materials for fabric belts
 - 12 - 13 Hot vulcanizing materials for steel cord belts
 - 14 Hot vulcanizing materials
 - 15 Cold vulcanizing materials with Repair kits
 - 16 - 21 Cold vulcanizing materials
 - 22 - 29 Pulley Lagging
 - 30 - 35 Wear Resistant Lining
 - 36 - 37 Standart Scraper Rubber
 - 38 Impact Aprons
- #### Conveyor belts
- 42 - 43 NILOS Conveyor belts
 - 44 - 45 Cleats and Sidewalls for bonding on conveyor belts
 - 46 Rubber Wear Protection Clamping Bars
 - 47 Impact Bars
 - 48 Jet-Streamer
 - 49 - 51 NILOS Rollers
 - 52 Idler Laggings

Mechanical Engineering

- 56 - 59 Vulcanizing Presses HYDRAULIC
- 60 - 63 Vulcanizing Press with Pressure bag EMU
- 64 - 65 Compact Press VULCOLITE
- 66 - 67 SPLICE-WATCH
- 68 VULCOFRAME
- 69 - 71 Repair Presses
- 72 - 73 ROTOCUT
- 74 - 75 Cord Stripper System
- 76 Belt Ripper

Tools

- 80 Screw Terminals and Belt and Clamps
- 81 Cable Winch, Ratchet Hook, Rope Block
- 82 Tool Bag
- 83 - 87 Small Tools
- 88 Rubber Cutting Machine
- 89 Regroover
- 90 - 91 Roughing Machine / Grindings
- 92 - 93 Accessoires
- 94 Cable Cutter

Services

- 98 - 99 Services, NILOS campus Belt Recycling
- 100 - 101 Technical questionnaire



ZILLER Holding



NILOS GmbH & Co. KG

Conveyor belt Equipment

- Installation service
- Scope of delivery and reconditioning of conveyor belts
- Wear resistant lagging and lining
- Vulcanizing presses
- Tools
- Materials for hot vulcanization, cold bonding and repair
- Spare parts
- Belt cleaning systems

info@nilos.de

Watch our Company-Movie on
www.nilos.de



ZILLER GmbH & Co. KG

Seals for Anti-friction Bearing

- NILOS-Ring for grease lubricated ball
- Roller and taper roller bearings
- Z and RS bearings
- NILOS-Ring LSTO labyrinth seals
- Distance rings

info@nilos-ring.de

www.nilos-ring.de



KROLL & ZILLER GmbH & Co. KG

Gasket Technology

- G-ST flange and profile gaskets
- Sealing technology
- Other flange gaskets and packings

info@kroll-ziller.de

www.kroll-ziller.de





NILOS



2017

Joint Venture with LUTZE Group
Foundation: NILOS Schweiz AG

2015

NILOS Rollers

2010

Certification of all companies within the
Ziller Holding according to DIN EN ISO 9001:2008

2009

New Scope: NILOS campus

1995

Introduction of the Quality Management system

1975

Various company acquisitions at home and abroad

1949

Foundation: NILOS GmbH

1941

Foundation: Ziller & Co. roller bearing seals
Foundation: Kroll & Ziller flange

1926

Engineering Office Paul Wever - Entry Hans J. Ziller

1951



1953



1956



1957

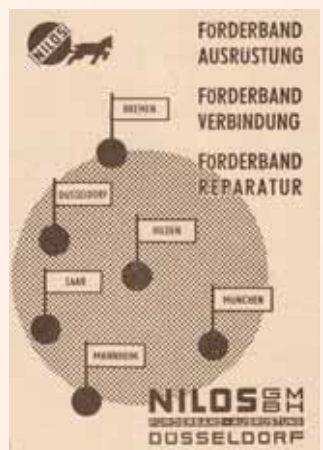

1965



1966







NILOS

Industrial Rubber

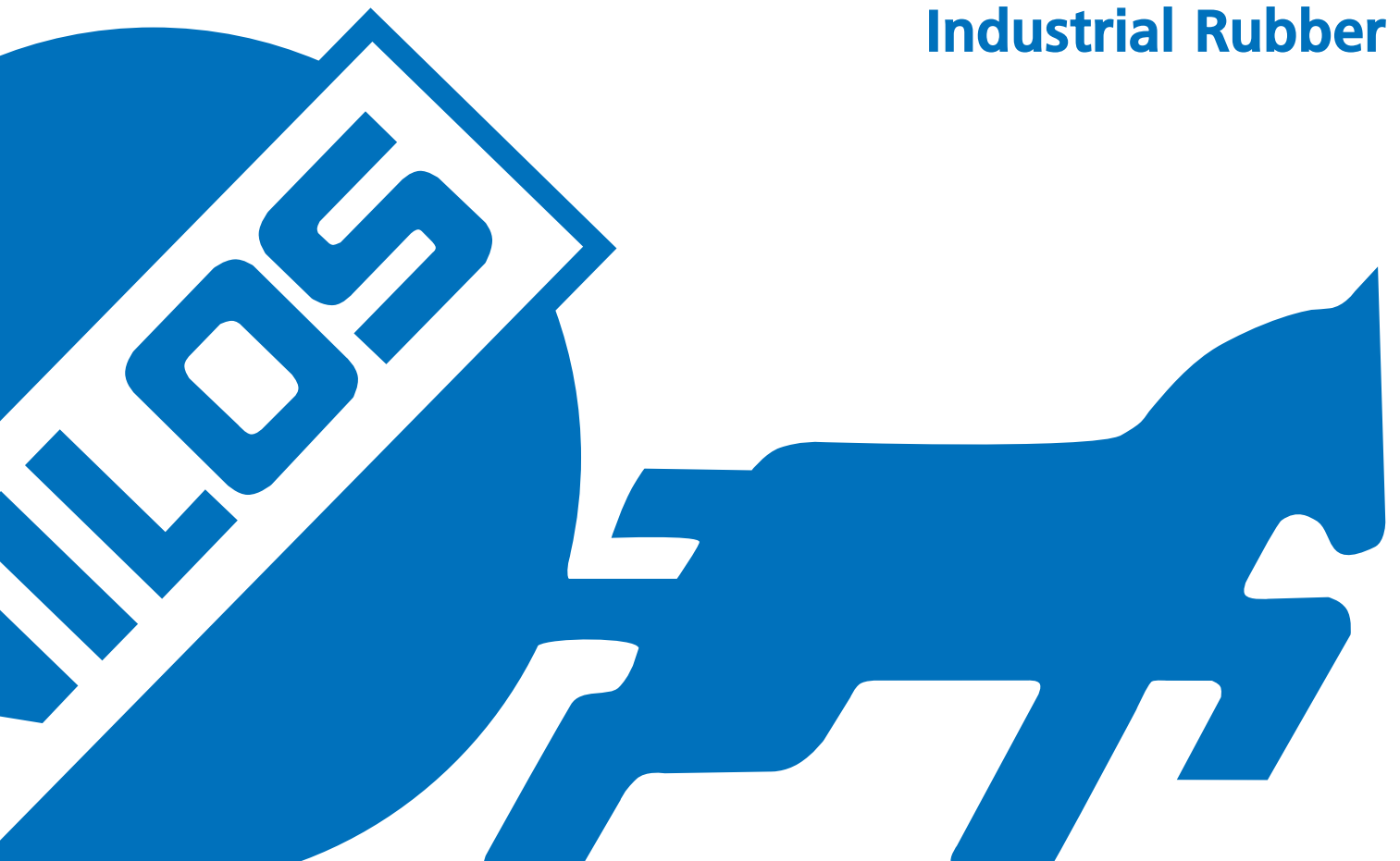

Hot vulcanizing Splicing kits
for steel and fabric belts



Hot vulcanizing Splicing kits for steel cord and fabric belts

General information about Splicing kits for steel cord and fabric conveyor belts.

NILOS splicing materials are designed with an overall composition to fit the conveyor belt compounds of most manufacturers.

Knowing technical details of the belt to be spliced, NILOS offers individually for every customer and every belt a splicing kit with all the components and amounts needed.

The following details are necessary:

- conveyor belt width
- details of quality (EP/ST)
- splicing length (alternativ as per DIN)
- rhombic 16° 42'; 22°, rectangular 90°
- thickness of top and bottom cover

Hot Splicing kits for fabric belts:

- Cover plate
- Intermediate rubber
- Hot-Solution L-1000
- Silicone paper

Hot Splicing kits for steel cord belts:

Top covers:

- Cover plate
- Core plate Type K-STG
- Pressure fabric

Bottom covers:

- Cover plate
- Core plate Type K-STG
- Shirting
- STG Rubber strips S-STG
- Hot-Solution STG-B



Our work instructions for hot processing
see www.nilos.de

Hot vulcanizing materials for fabric belts

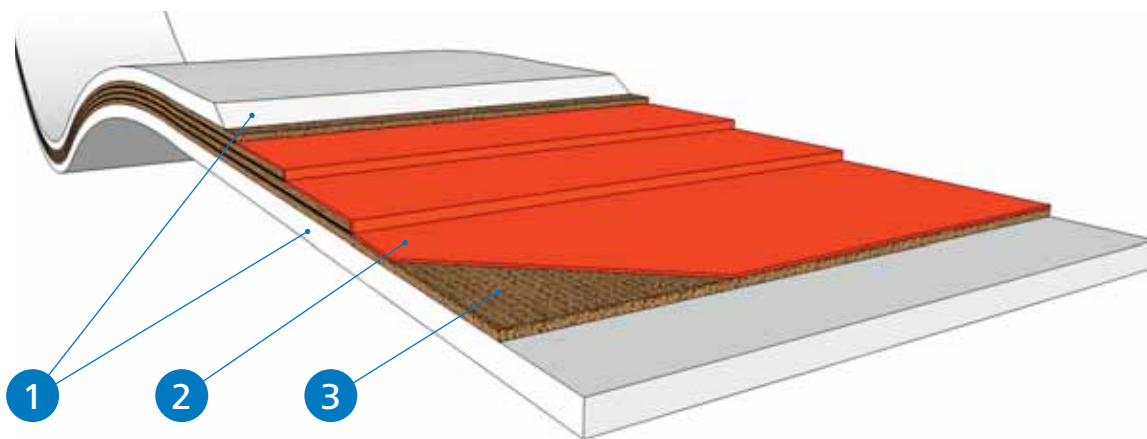

1 Cover plate Type D-Gi-X, uncured, black, Elastomer SBR, NR

Density	1,13 g/cm ³	DIN 53479
Hardness	60 ± 5 Sh° A	DIN 53505
Abrasion	115 mm ³	DIN 53516

Thickness *	Width *	Item no.
1 mm	500 mm	H 0277-N
2 mm		H 0278-N
3 mm		H 0279-N
4 mm		H 0280-N
5 mm		H 0281-N
6 mm		H 0282-N

2 Intermediate Rubber Type Z-Gi-X uncured, black

Density	1,19 g/cm ³	DIN 53479
Hardness	65 ± 5 Sh° A	DIN 53505

Thickness	Width	Item no.
0,8 mm	500 mm	H 0295-N
1,0 mm		H 0206-N

1 Cover plate Type D-Gi-V, uncured, self-extinguishing quality, black, Elastomer CR

Density	1,49 g/cm ³	DIN 53479
Hardness	65 ± 5 Sh° A	DIN 53505

Thickness *	Width *	Item no.
1 mm	500 mm	H 0283-N
2 mm		H 0284-N
3 mm		H 0285-N
4 mm		H 0286-N
5 mm		H 0287-N
6 mm		H 0288-N

2 Intermediate Rubber Type Z-Gi-V uncured, self-extinguishing quality, black

Density	1,49 g/cm ³	DIN 53479
Hardness	65 ± 5 Sh° A	DIN 53505

Thickness	Width	Item no.
0,8 mm	500 mm	H 0207-N
1,0 mm		H 0208-N

Hot vulcanizing materials for fabric belts

General Information

To splice or repair a fabric belt, apart from the vulcanizing solution, uncured material as cover plate and intermediate rubber is required.

Our work instructions for hot processing see www.nilos.de.

1

Cover plate Type D-Gi-NBR, uncured, oil- and grease-resistant, black, Elastomer NBR

Density	1,23 g/cm ³	DIN 53479
Hardness	65 ± 5 Sh° A	DIN 53505
Abrasion	145 mm ³	DIN 53516
Thickness *	Width *	Item no.
1 mm	500 mm	H 0200-N
2 mm		H 0201-N
3 mm		H 0202-N
4 mm		H 0203-N
5 mm		H 0204-N
6 mm		H 0205-N

2

Intermediate Rubber Type Z-Gi-NBR, uncured, oil- and grease-resistant, black, Elastomer NBR

Density	1,23 g/cm ³	DIN 53479
Hardness	65 ± 5 Sh° A	DIN 53505
Abrasion	145 mm ³	DIN 53516
Thickness	Width	Item no.
0,8 mm	500 mm	H 0209-N
1,0 mm		H 0210-N



3

Fabric for hot vulcanizing, rubberized on both sides, uncured

Width x Length *	Type	Item no.
1.000 x 10.000 mm	EP 160	H 0305

other materials can be found on page 14

Hot vulcanizing materials for steel cord belts

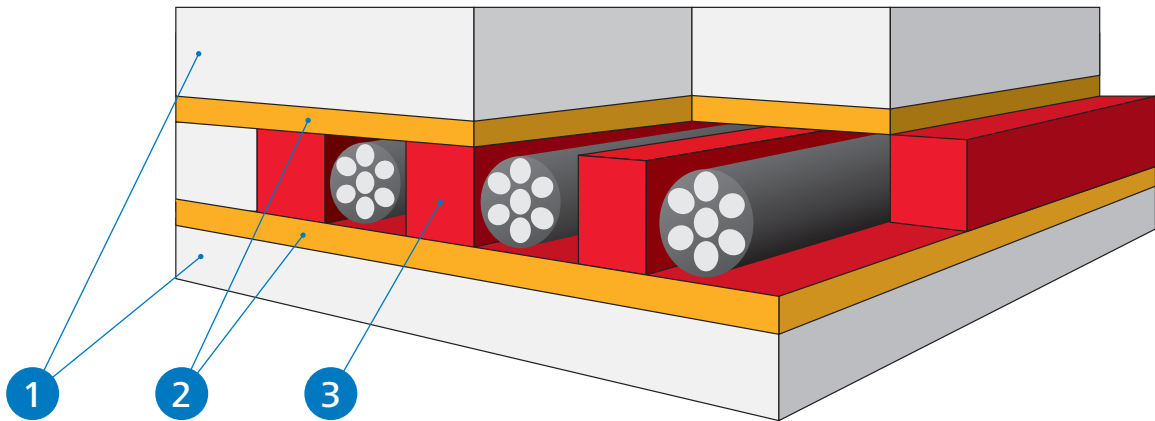

1

Cover plate Type D-Gi-X, uncured,
black, Elastomer SBR, NR

Density	1,13 g/cm ³	DIN 53479
Hardness	60 ± 5 Sh° A	DIN 53505
Abrasion	115 mm ³	DIN 53516

Thickness *	Width *	Item no.
1 mm	500 mm	H 0277-N
2 mm		H 0278-N
3 mm		H 0279-N
4 mm		H 0280-N
5 mm		H 0281-N
6 mm		H 0282-N

1

Cover plate Type D-Gi-Y, uncured,
black, Elastomer SBR, NR

Density	1,15 g/cm ³	DIN 53479
Hardness	60 ± 5 Sh° A	DIN 53505
Abrasion	< 100 mm ³	DIN 53516

Thickness *	Width *	Item no.
1 mm	500 mm	H 0277-Y
2 mm		H 0278-Y
3 mm		H 0279-Y
4 mm		H 0280-Y
5 mm		H 0281-Y
6 mm		H 0282-Y

1

Cover plate Type D-Gi-V, uncured,
self-extinguishing quality, black, Elastomer CR

Density	1,49 g/cm ³	DIN 53479
Hardness	65 ± 5 Sh° A	DIN 53505

Thickness *	Width *	Item no.
1 mm	500 mm	H 0283-N
2 mm		H 0284-N
3 mm		H 0285-N
4 mm		H 0286-N
5 mm		H 0287-N
6 mm		H 0288-N

Hot vulcanizing materials for steel cord belts

General Information

The following components are required to splice or repair steel cord belts:

- vulcanizing solution
- uncured rubber
(Cover plate, Core plate and Rubber strips).

Our work instructions for hot processing see www.nilos.de.

2

Core plate Type K-STG, uncured

Thickness *	Width *	Item no.
2 mm	500 mm	H 0297-N



3

STG Rubber strips Type S-STG, uncured

Thickness x Width *	VPE	for steel cord	Item no.
2,0 x 5 mm		ST 1000	H 0299-A
2,5 x 6 mm		ST 1250	H 0271-B
2,0 x 7 mm		ST 1600	H 0299
2,5 x 7 mm		ST 2000	H 0271-A
2,5 x 8 mm	2 kg	ST 2500	H 0271
2,0 x 9 mm		ST 3500	H 0299-B
2,0 x 11 mm		ST 4500	H 0272-C
2,0 x 12 mm		ST 5000	H 0272-A
2,0 x 13 mm		ST 5400	H 0272-B

The rubber strips can be used with NILOS hand extruder on page 21.

other materials can be found on page 14

Hot vulcanizing materials

Shirting

Width	Length *	Item no.
1.000 mm	50 m	H 0316



Silicon paper

Width	Length *	Item no.
1.000 mm	50 m	H 0317-C



Pressure fabric

Width	Length *	Item no.
1.000 mm	10 m	H 0318



STG-B, flammable

Solution *	Unit	Item no.
650 g	Tin	H 0312

Solution for hot repairs and splicing of fabric and steel cord conveyor belts



L-1000, flammable

Solution *	Unit	Item no.
650 g	Tin	H 0308

Solution for hot repair and splicing of fabric conveyor belts



Cold vulcanizing materials with Repair kits

General information about cold materials with
Repair kits.

Our repair materials are perfectly matched.

With information of the conveyor belt to be joined
is customized for a matching connector kit with all the
components and quantities required to specified and
available.

Repair kits for fabric belts:

- Hard cover TH
- Cover layer TOPGUM TD and TDG
- Cold cement TOPGUM TL-T60
- Filler layer TOPGUM TS



Our work instructions for cold processing
see www.nilos.de

RELIABLE EVEN BETTER. TRI-FREE

TRICHLORETHYLEN(E) FREI/FREE





NILOS

NON FLAMMABLE *NO BENZINE AND FREE OF TRICHLOROETHYLENE*

Cold cement for repair of fabric and steel cord conveyor belts and splicing of fabric conveyor belts.



TOPGUM TL-T70 **TRI-FREE**
free of trichloroethylene, non flammable

Cement	Hardener	Unit	Item no.
1000 g	1 x 40 g	1 Set	H 0257
1000 g	-	Tin	H 0257-K

Solution for hot repair and splicing of fabric and steel cord conveyor belts



STG-FW **TRI-FREE**
free of trichloroethylene, non flammable

Solution	Unit	Item no.
1000 g	Tin	H 0313

Change now

- alternative to the known products
- identical properties with optimized formula
- application in the usual NILOS Quality



Cold cement

TOPGUM TL-T50, flammable

Cement *	Hardener	Unit	Item no.
700 g	1 x 40 g	1 Set	H 0050
700 g	-	Tin	H 0050-K

Cold cement, especially for large surfaces, e.g. lining.



TOPGUM TL-T60, flammable

Cement *	Hardener	Unit	Item no.
700 g	1 x 40 g	1 Set	H 0259
700 g	-	Tin	H 0259-K

Cold cement for repair of fabric and steel cord conveyor belts and splicing of fabric conveyor belts.



TOPGUM TL-PVC, flammable

Cement *	Hardener	Unit	Item no.
650 g	1 x 40 g	1 Set	H 0269
650 g	-	Tin	H 0269-K

Cold cement for repair and splicing of PVC conveyor belts.



TOPGUM TL-W, flammable

Cement *	Hardener	Unit	Item no.
700 g	1 x 40 g	1 Set	H 0273
700 g	-	Tin	H 0273-K

Cold cement for repair and splicing of fabric conveyor belts in food applications.



Universal Hardener, non flammable

Hardener	Unit	Item no.
1 x 40 g	Bottle	H 0050-H

Universal Hardener for all NILOS cold cement.



Materials for Preparing of Surfaces

For preparation of metal surfaces before bonding of rubber and metal by glueing with cold cement.



Primer SH, CHC-free, flammable

Unit *	Item no.
735 g Tin	H 1139

For degreasing of surfaces polluted by oil and grease, cleaning of brushes and removing of pollution by cement and vulcanizing solutions.



Cleaning fluid type B, CHC-free, flammable

Unit *	Item no.
500 ml Tin	H 0315

For the repair of cover plate and processing Rubber strips STG. With air deflector.



Handextruder

Capacity	Weight	Item no.
1.150 W, 230 V, 50 Hz	approx. 6,9 kg	K 0651
1.150 W, 110 V, 50 Hz		K 0651-A
Round nozzle	-	K 0670
Flat nozzle	-	K 0671



Two component repair strips G+S

Type	Unit	Item no.
G (grey)	2 kg	H 0329-G
S (black)		H 0329-S
GS (grey + black)	2 x 2 kg	H 0329-GS
Cleaning mixture	2 kg	H 0331-V
apply accordingly TOPGUM TL-T60		H 0259

Materials for cold vulcanizing

Filler layer TOPGUM TS

Thickness	Width	Length *	Item no.
3 mm	25 mm	10.000 mm	H 0100
	50 mm		H 0101
	75 mm		H 0223
	100 mm		H 0224
	150 mm		H 0225
	200 mm		H 0226
	500 mm		H 0227

Filler layer with bonding layer on both sides for repair of rubber conveyor belts. Also available in V quality (self-extinguishing quality).



Cover layer TOPGUM TD, with sloped edges on both sides

Thickness	Width	Length *	Item no.
2 mm	100 mm	10.000 mm	H 0102
3 mm			H 0230
5 mm			H 0231
2 mm	150 mm		H 0103
3 mm			H 0233
5 mm			H 0234
2 mm	200 mm	H 0104	
3 mm		H 0236	
5 mm		H 0237	
2 mm	250 mm	H 0105	
3 mm		H 0239	
5 mm		H 0240	
2 mm	500 mm	H 0106	
3 mm		H 0242	
5 mm		H 0243	

Cover layer with bonding layer on one side for repair of rubber conveyor belts. Also available in V-Quality (self-extinguishing quality) and oil- and grease-resistant.



Cover layer TOPGUM TDG, tapered edges both sides

Thickness	Width	Length *	Item no.
3 mm	100 mm	10.000 mm	H 0229-G
	150 mm		H 0230-G
	250 mm		H 0231-G
	300 mm		H 0232-G
	400 mm		H 0233-G
	500 mm		H 0234-G

Cover layer with bonding layer on one side with fabric reinforcement for repair of rubber conveyor belts. Also available in V-Quality (self-extinguishing quality) and oil- and grease-resistant.



Materials for cold vulcanizing

Repair patches with bonding layer on one side for repair of rubber conveyor belts.



Repair patches TOPGUM TD and TOPGUM TDG with fabric reinforcement tapered edges

Thickness	Width x Length *	TD Item no.	TDG Item no.
3 mm	100 x 100 mm	H 0131	H 0141-G
	150 x 150 mm	H 0132	H 0142-G
	200 x 200 mm	H 0133	H 0143-G
	300 x 300 mm	H 0134	H 0144-G

Rubberized fabric with bonding layer on both sides for cold repair of fabric conveyor belts.



Fabric TOPGUM TG, cured

Type	Width	Length *	Item no.
TG 200 EP 160	200 mm	10.000 mm	H 0250
TG 400 EP 160	400 mm		H 0432
TG 600 EP 160	600 mm		H 0251
TG 1200 EP 160	1.200 mm		H 0301

Hard cover with bonding layer on one side for repair and splicing of rubber conveyor belts. Also available in V-Quality (self-extinguishing quality).



Hard cover TH, edges without slopes

Thickness	Width	Length *	Item no.
2 mm	500 mm	10.000 mm	H 0108
3 mm			H 0246
4 mm			H 0247
5 mm			H 0248
6 mm			H 0249



Cold film TM

Thickness	Width	Length *	Item no.
1 mm	100 mm	10.000 mm	H 0253
	500 mm		H 0254

Pulley Lagging
Type RB

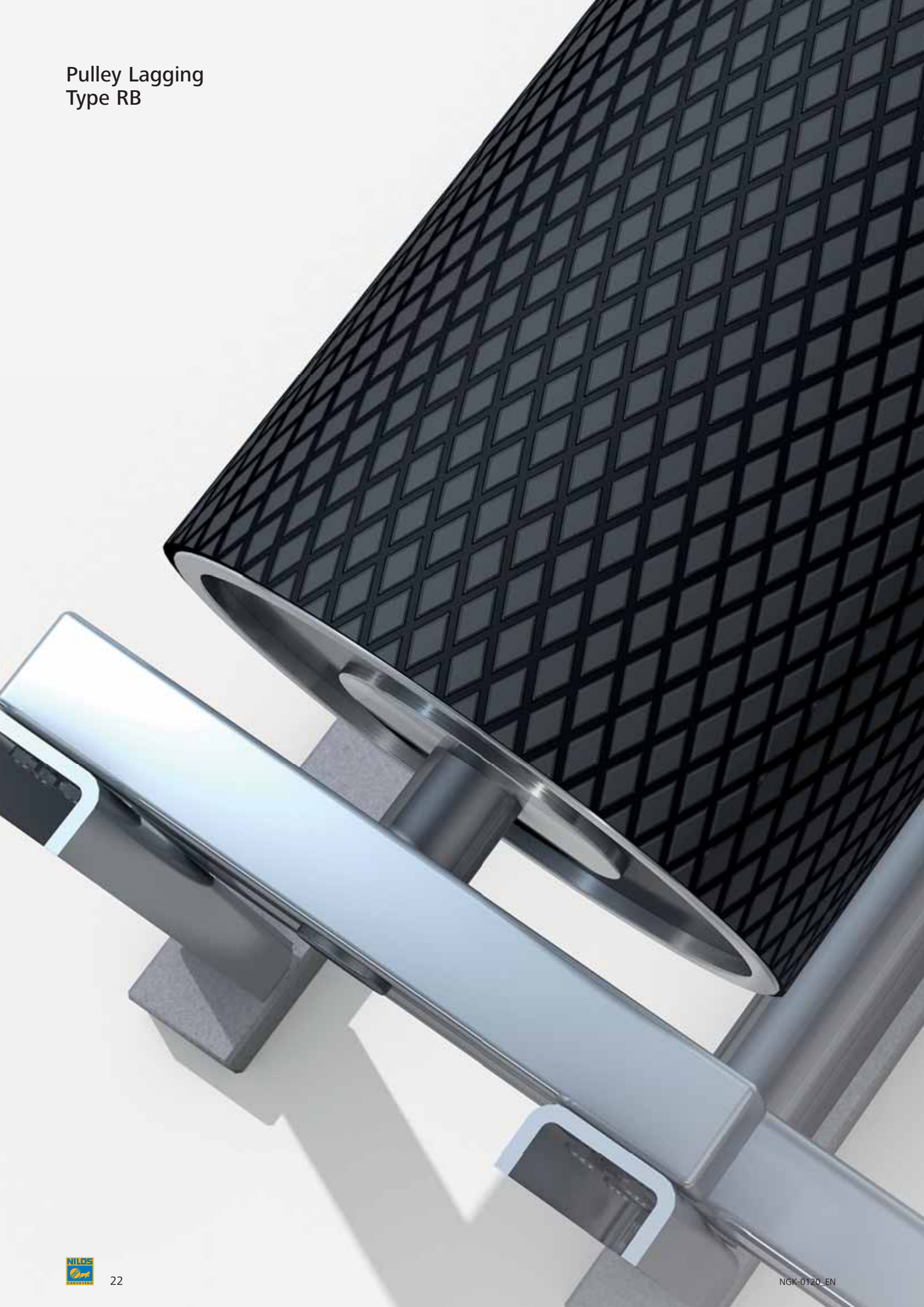

**THE GROOVED
PULLEY LAGGING**
everything is just right.

Wear resistant drum lagging made of rubber, plain or profiled, with or without adhesive layer in different qualities.

- Pulley lining for increasing of the friction value between conveyor belt and pulley
- minimizing of the belt slip, and improvement of self-cleaning.
- protection of the pulley to prevent wearing off and corrosion
- Prevents material build-up

Quality *	Hardness DIN 53505	Abrasion DIN 53516	Elasticity DIN 53512	Colour	Properties
U60	60 ± 5 Sh° A	115 mm ³	35%	black	very good resistance to abrasion
U70	70 ± 5 Sh° A	115 mm ³	35%		good resistance to abrasion with high hardness
TB60	60 ± 5 Sh° A	100 mm ³	30%		good resistance to abrasion
V	65 ± 5 Sh° A	200 mm ³	30%		antistatic and extinguishing
NBR	65 ± 5 Sh° A	145 mm ³	25%		oil- and grease-resistant

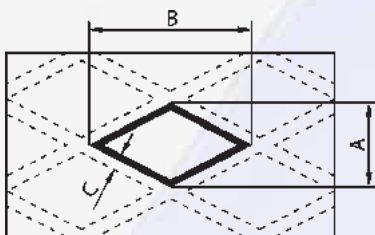

Diamond grooves

	Height A	Width B	Distance C	Depth
small	17 mm	33 mm	6 mm	3 mm
large	51 mm	88 mm	6 mm	4 mm

Our work instructions for rubber cylinder coatings see www.nilos.de

Grooved Pulley Lagging Type RB

Grooved Pulley Lagging RB - small diamond groove
with bonding layer *



Thickness	Width	Length	Quality				
			U60 Item no.	U70 Item no.	TB60 Item no.	V Item no.	NBR Item no.
8 mm	2.000 mm	10.000 mm	T 1502-2	T 1520-2	T 1946-2	T 1556-2	T 1808-2
10 mm			T 1504-2	T 1522-2	T 1948-2	T 1558-2	T 1810-2

Grooved Pulley Lagging RB - large diamond groove
with bonding layer *



Thickness	Width	Length	Quality				
			U60 Item no.	U70 Item no.	TB60 Item no.	V Item no.	NBR Item no.
12 mm	2.000 mm	10.000 mm	T 1505-3	T 1523-3	T 1950-3	T 1559-3	T 1811-3
15 mm			T 1506-3	T 1524-3	T 1953-3	T 1560-3	T 1812-3
20 mm			T 1507-3	T 1525-3	-	-	T 1813-3

Material for cold processing on pages 15 - 18

Pulley Lagging Type RB

Plain Pulley Lagging RB with bonding layer *



Thickness	Width	Length	Quality			
			U60 Item no.	U70 Item no.	V Item no.	NBR Item no.
8 mm	2.000 mm	10.000 mm	T 1502-1	T 1520-1	T 1556-1	T 1808-1
10 mm			T 1504-1	T 1522-1	T 1558-1	T 1810-1
12 mm			T 1505-1	T 1523-1	T 1559-1	T 1811-1
15 mm			T 1506-1	T 1524-1	T 1560-1	T 1812-1
20 mm			T 1507-1	T 1525-1	-	T 1813-1



Pulley lagging made of rubber

- for increasing the friction value between conveyor belt and pulley
- minimizing the belt slip and improvement of self-cleaning
- protection of the pulley to prevent wearing off and corrosion

Thickness	Width	Length	Item no.
12 mm	410 mm	6.500 mm	X 2901012
		10.000 mm	
		20.000 mm	

Ceramic Pulley Lagging
Type RB-K

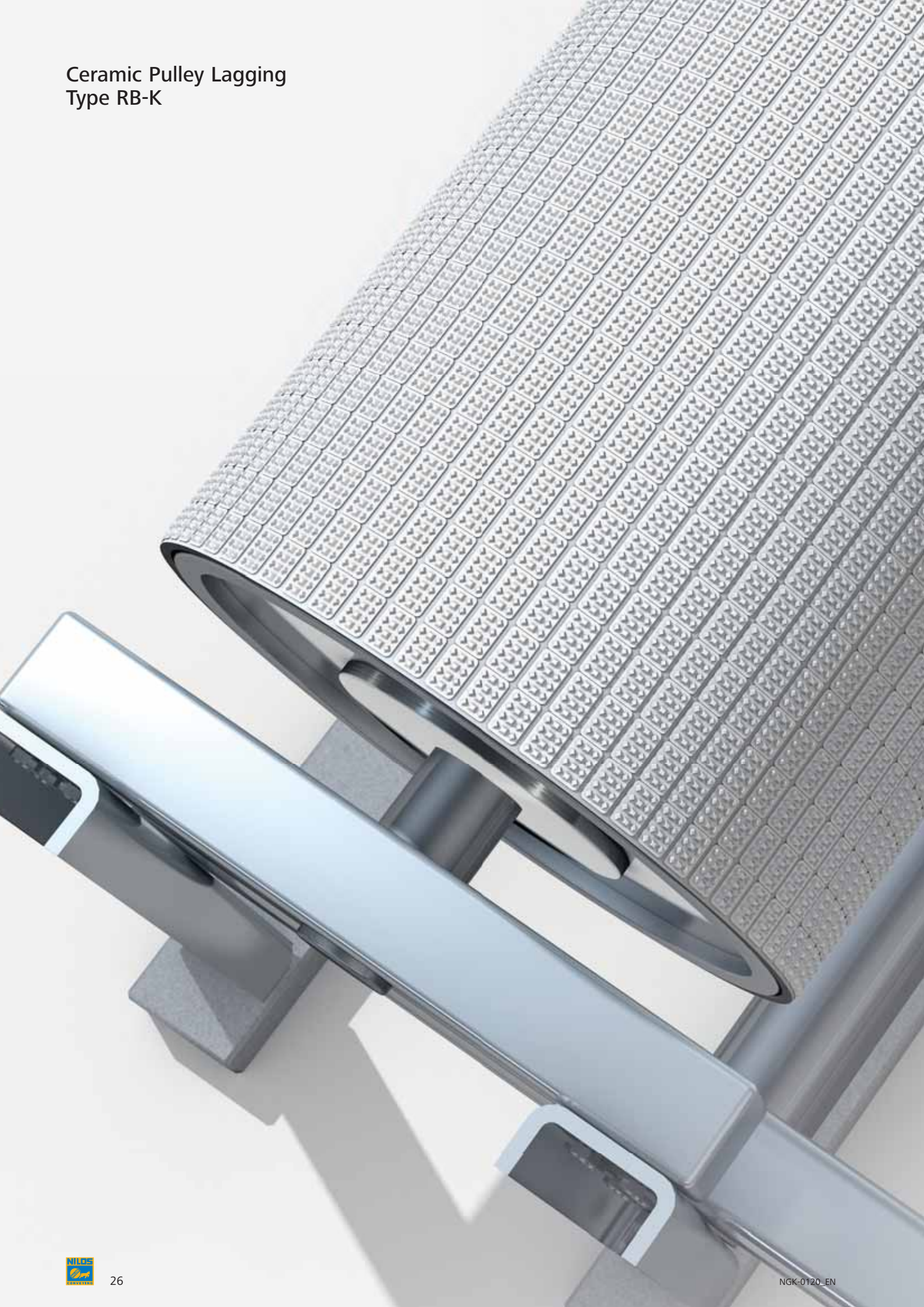

CERAMIC LAGGINGS
*with maximum performance
for drive drums*

NEW NILOS AL₂O₃-ceramics

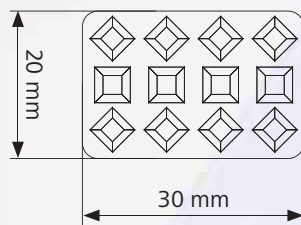

Use the best technologies and maximize the efficiency of your overall system!

Maximum plant availability, productivity and operational reliability and safety and smooth workflows during the whole conveying cycle. Reliability for the highest demands.

- Special new NILOS AL₂O₃ ceramic profile for belt-preserving operation with significantly increased traction
- Pulley lagging with more than 40% or 100% coverage by ceramic material, for conditions of use involving high exposure to wear
- Wide operating temperature range (-40° C to +120 °C)
- Thermal, mechanical and chemical resistance
- Belt preserving elastic rubber substructure with adhesive layer
- High wear resistance
- Outstanding self-cleaning effect
- Reliable operation even in the case of wet, clayey and muddy conveying conditions
- Simple gluing by means of NILOS contact layer
- During processing reduction of the cut waster to a minimum as it can be cut horizontally and vertically
- Simple covering of pulleys also in installed state

Our work instructions for rubber cylinder coatings see www.nilos.de

Ceramic Pulley Lagging Type RB-K

Pulley lagging RB-K made of rubber/ceramic for drive pulleys *

- elastic rubber base to reduce belt wear, with adhesive layer
- superior drive traction allows lower belt tension
- high wear-resistant
- very good self-cleaning effect
- easy bonding with TOPGUM

Thickness	Width	Length	Item no.
12 mm	204 mm	700 mm	T 1807
		900 mm	T 1808
		1.000 mm	T 1809
		1.100 mm	T 1810
		1.200 mm	T 1811
		1.300 mm	T 1812
		1.500 mm	T 1813
		1.700 mm	T 1814
		2.000 mm	T 1815
		2.500 mm	T 1816



Pulley lagging RBK-RN made of rubber/ceramic for drive pulleys

NILOS AL₂O₃-ceramic material: triangular approx. 1 mm studded, 4 mm thick. Rubber support: 60 ± 5 Sh° A with bonding layer

- Medium to severe operating conditions
- for medium to large drive rollers with fabric belts
- Excellent traction (coefficient of friction) permits low belt tensions
- high wear-resistant
- very good self-cleaning effect
- easy bonding with TOPGUM

Thickness	Width	Length	Item no.
12 mm	410 mm	6.500 mm	X 2801012



Material for cold processing on pages 15 - 18



NEW NILOS AL₂O₃-ceramics



Pulley lagging RBK-R70 made of rubber/ceramic for drive pulleys *

NILOS AL₂O₃-ceramic: with dimensions 10 x 20 x 30 mm Stone with rounded corners and profiling from 2 mm high, blunt-topped square pyramids. Rubber support: 70 ± 5 Sh° A with contact layer.

- Medium to heavy conditions
- for medium to large drive pulleys with fabric belts
- Excellent traction (coefficient of friction) permits low belt tensions
- high wear-resistant
- very good self-cleaning effect
- easy bonding with TOPGUM

Thickness	Width	Length	Item no.
15 mm	385 mm	1.130 mm	T1889

Also available as rubber/rubber lagging.



“Solid” ceramic lagging type RB-CP for drive pulleys

NILOS AL₂O₃-ceramic: with dimensions 10 x 20 x 30 mm Stone with rounded corners and profiling from 2 mm high, blunt-topped square pyramids (packaged on supports).

- Extreme conditions of use
- for medium to large drive pulleys with steel cord or fabric belts
- Excellent traction (coefficient of friction) permits low belt tensions
- minimum wear

Thickness	Width	Length	Item no.
10 mm	500 mm	500 mm	T5000

Wear Resistant Lining Type RX

- protection against wear and corrosion
- prevents material build-up
- high resilience and elasticity
- reinforced on request

Quality	Hardness DIN 53505	Abrasion DIN 53516	Elasticity DIN 53512	Colour	Properties
35	35 ± 5 Sh° A	220 mm ³	70%	coloured **	especially soft with exceptionally high elasticity
40 <i>ECO</i>	40 ± 5 Sh° A	< 200 mm ³	40%	black	with well-balanced and physical properties
45	45 ± 5 Sh° A	< 200 mm ³	65%	coloured **	soft with exceptionally high elasticity
V	60 ± 5 Sh° A	130 mm ³	35%	black	antistatic and extinguishing
NBR	40 ± 5 Sh° A	180 mm ³	35%		oil- and grease-resistant

Wear resistant Lining RX with bonding layer *



Thickness	Width	Length	Quality				
			35 Item no.	40 <i>ECO</i> Item no.	45 Item no.	V Item no.	NBR Item no.
8 mm	2.000 mm	10.000 mm	T 1592	T 2005	T 1610	T 1646	T 1664
10 mm			T 1593	T 2010	T 1611	T 1647	T 1665
12 mm			T 1594	T 2012	T 1612	T 1648	T 1666
15 mm			T 1595	T 2015	T 1613	T 1649	T 1667
20 mm			T 1596	-	T 1614	T 1650	T 1668

* Other materials and qualities on request,
also available without bonding layer
** beige, yellow, green, red, blue and black

Wear Resistant Lining Type RV

- with or without bonding layer
- universal, weatherproof, wear resistant Lining
- protection against noise, wear and corrosion
- prevents material build-up

Quality	Hardness DIN 53505	Abrasion DIN 53516	Elasticity DIN 53512	Colour	Properties
VS60	60 ± 5 Sh° A	150 mm ³	30%	black	for a wide range of applications
AB	60 ± 5 Sh° A	115 mm ³	35%		for a wide range of applications
A	65 ± 5 Sh° A	80 mm ³	40%		high resistance to abrasion
V	60 ± 5 Sh° A	130 mm ³	35%		antistatic and extinguishing
NBR	65 ± 5 Sh° A	145 mm ³	25%		oil- and grease-resistant



Wear resistant Lining RV with bonding layer *

Thickness	Width	Length	Quality				
			VS60 Item no.	AB Item no.	A Item no.	V Item no.	NBR Item no.
8 mm	2.000 mm	10.000 mm	T 1966-1	T 1445	T 1682	T 1772	T 1867
10 mm			T 1968-1	T 1446	T 1683	T 1773	T 1868
12 mm			T 1970-1	T 1447	T 1684	T 1774	T 1869
15 mm			T 1973-1	T 1448	T 1685	T 1775	T 1870
20 mm			-	T 1489	T 1686	T 1776	T 1871

Material for cold processing on pages 15 - 18

Ceramics Wear Resistant Lining Type RK

Ceramic Wear resistant Lining made for use under hard operational conditions.

- ceramic elements made of alumina oxide (Al_2O_3 = corundu) vulcanized into a shock absorbant rubber mat.
- cold bonding of segment plates on steel surfaces by additional bonding layer on the bottom side of rubber plates
- optimal sliding properties
- water-repelling
- high resistance against abrasion

Applications

- in mining, e.g. in coal preparation
- in glass industry
- chutes, slides, even in case of sliding dry friction
- in case of highly corrosive goods



Ceramics Wear resistant Lining RK with bonding layer

Thickness x Width x Length *	Ceramics (T x W x L)	Rubber-Thickness	Item no.
3,5 x 500 x 500 mm	1,5 x 10 x 10 mm	2 mm	T 1884
8 x 500 x 500 mm	4 x 20 x 20 mm	4 mm	T 1830
10 x 500 x 500 mm	6 x 20 x 20 mm	4 mm	T 1887
14 x 500 x 500 mm	10 x 20 x 20 mm	4 mm	T 1888

Material for cold processing on pages 15 - 18

PE-Polyethylene Wear Resistant Lining Type RM

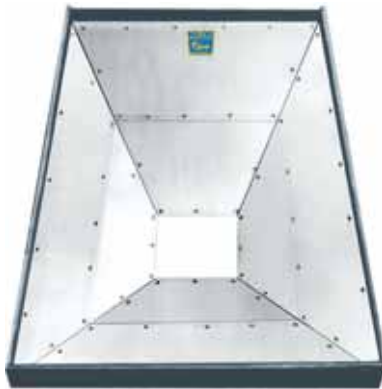

Wear resistant Lagging for lining and protection against noise, abrasion and corrosion and prevention from sticking on of conveyed goods.

Application

- coal mining
- in case of damp or watery conveyed goods
- chutes
- slides
- in case of high corrosive goods

Properties

- high wear resistant
- optimum protection from build-up bulk materials
- optimal sliding, even in case of temperatures under 0° C
- resistant against chemicals
- very good noise reducing properties
- UV protected

Quality	1000
Specific weight	0,93 g/cm ²
Softening temperature	133 - 135 °C
Notch impact strength	210 kJ/m ²
Molecular weight	approx. 3,5 Mio.
Colour	natural white

Mechanical fixing with

- screws
- cotter pin
- clinch

Possible handling

- saw
- rotating
- shaping
- milling
- boring
- perforating
- welding

Wear resistant Lining RM *

Thickness	Width	Length	Item no.
8 mm			T 1186
10 mm			T 1187
12 mm	1.000 mm	2.000 mm	T 1188
15 mm			T 1189
20 mm			T 1190

Wear resistant Lining RM *

Thickness	Width	Length	Item no.
8 mm			T 1174
10 mm			T 1175
12 mm	1.000 mm	1.000 mm	T 1192
15 mm			T 1193
20 mm			T 1176

Maximum manufacturing sizes

Width	Length
1.000 mm	4.000 mm
2.000 mm	4.000 mm
	6.000 mm
1.000 mm	8.000 mm

PU-Polyurethane Wear Resistant Lining Type RP

Application

- in case of damp or watery conveyed goods
- chutes, slides; even in case of sliding dry friction
- extremely high temperatures
- extremely corrosive goods

Quality

	Hardness DIN 53505	Abrasion DIN 53516	Elasticity DIN 53512	Colour
65	65 ± 5 Sh° A	44 mm ³	62%	blue
85	80 ± 5 Sh° A	31 mm ³	51%	

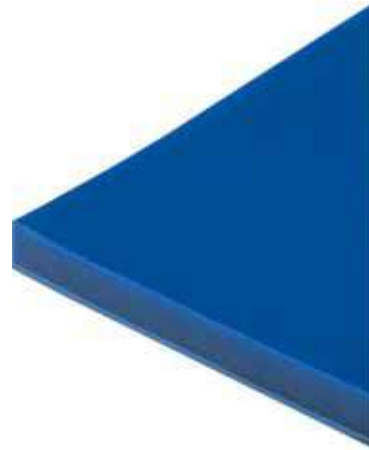

Properties

- all-purpose wear protection
- weatherproof
- protection against noise, wearing and corrosion
- prevents material build-up
- highly resistant against notches
- oil- and grease-resistant
- temperature resistant up to +90°

PU-Polyurethane Wear resistant Lining RP with bonding layer *

Thickness	Width	Length	Quality	
			65 Item no.	85 Item no.
8 mm	2.000 mm	1.000 mm	T 1841	T 1846
10 mm			T 1842	T 1847
12 mm			T 1843	T 1848

Material for cold processing on pages 15 - 18

Standard Scraper Rubber Type AN, AV, ANBR und AH



Standard Scraper Rubber

High abrasion resistant scraper rubber and Lateral scraper rubber for all applications.

Type AN

Standard scraper for a wide variety of applications.

Type AV

Antistatic and extinguishing.

Type ANBR

Oil- and grease-resistant.

Type AH

Standard scraper with high shore hardness.

Quality	Hardness DIN 53505	Abrasion DIN 53516	Elasticity DIN 53512	Colour	Properties
AN	60 ± 5 Sh° A	115 mm ³	35%	black	wide range of applications
AV	70 ± 5 Sh° A	125 mm ³	30%		antistatic and extinguishing
ANBR	65 ± 5 Sh° A	145 mm ³	25%		oil- and grease-resistant
AH	80 ± 5 Sh° A	150 mm ³	25%		with high shore hardness

Thickness	Width	Length *	AN Item no.	AV Item no.	ANBR Item no.	AH Item no.
10 mm	100 mm	10.000 mm	T 0953	T 0965	T 0977	T 1019
15 mm			T 0954	T 0966	T 0978	T 1020
20 mm			T 0955	T 0967	T 0979	T 1021
10 mm	125 mm		T 0956	T 0968	T 0980	T 1022
15 mm			T 0957	T 0969	T 0981	T 1023
20 mm			T 0958	T 0970	T 0982	T 1024
10 mm	150 mm		T 0959	T 0971	T 0983	T 1025
15 mm			T 0960	T 0972	T 0984	T 1026
20 mm			T 0961	T 0973	T 0985	T 1027
15 mm	200 mm		T 0962	T 0974	T 0986	T 1028
20 mm			T 0963	T 0975	T 0987	T 1029

* Other contents on request

Combination Scraper Rubber Type AKN, AKV und AKNBR

Combination Scraper Rubber with signal layer.

High abrasion resistant scraper rubber for all applications.

Type AKN

Combination scraper (3-layers) for normal applications.

Type AKV

Combination scraper (3-layers), antistatic and extinguishing.

Type AKNBR

Combination scraper (3-layers), oil- and grease-resistant.



Quality	Hardness DIN 53505	Abrasion DIN 53516	Elasticity DIN 53512	Colour	Properties
AKN	60 ± 5 Sh° A	115 mm ³	35%	black	wide range of applications
	50 ± 5 Sh° A	220 mm ³	75%	coloured **	
	60 ± 5 Sh° A	115 mm ³	35%	black	
AKV	70 ± 5 Sh° A	125 mm ³	30%	black	antistatic and extinguishing
	55 ± 5 Sh° A	270 mm ³	40%	coloured **	
	70 ± 5 Sh° A	125 mm ³	30%	black	
AKNBR	65 ± 5 Sh° A	145 mm ³	25%	black	oil- and grease-resistant
	40 ± 5 Sh° A	180 mm ³	35%	coloured **	
	65 ± 5 Sh° A	145 mm ³	25%	black	

Thickness	Width	Length *	AKN Item no.	AKV Item no.	AKNBR Item no.
15 mm	100 mm	10.000 mm	T 1054	T 1066	T 1078
20 mm			T 1055	T 1067	T 1079
30 mm			T 1056	T 1068	T 1080
15 mm	125 mm		T 1057	T 1069	T 1081
20 mm			T 1058	T 1070	T 1082
30 mm			T 1059	T 1071	T 1083
15 mm	150 mm		T 1060	T 1072	T 1084
20 mm			T 1061	T 1073	T 1085
30 mm			T 1062	T 1074	T 1086
15 mm	200 mm		T 1063	T 1075	T 1087
20 mm			T 1064	T 1076	T 1088
30 mm			T 1065	T 1077	T 1089

Lateral Scraper Rubber Type AXN, AXV und AXNBR



Lateral scraper rubber

High abrasion lateral scraper rubber for all applications.

Type AXN

Lateral scraper rubber made of soft rubber with high elasticity.

Type AXV

Lateral scraper rubber, antistatic and extinguishing, with high elasticity.

Type AXNBR

Reflex scraper, oil-resistant with high elasticity.

Quality	Hardness DIN 53505	Abrasion DIN 53516	Elasticity DIN 53512	Colour	Properties
AXN	45 ± 5 Sh° A	220 mm ³	65%	coloured **	soft, high elasticity
AXV	55 ± 5 Sh° A	270 mm ³	40%	black	antistatic and extinguishing, high elasticity
AXNBR	40 ± 5 Sh° A	180 mm ³	35%		oil- and grease-resistant, high elasticity

Thickness	Width	Length *	AXN Item no.	AXV Item no.	AXNBR Item no.
10 mm	100 mm	10.000 mm	T 0989	T 0999	T 1009
15 mm			T 0990	T 1000	T 1010
20 mm			T 0991	T 1001	T 1011
10 mm	125 mm		T 0992	T 1002	T 1012
15 mm			T 0993	T 1003	T 1013
20 mm			T 0994	T 1004	T 1014
10 mm	150 mm		T 0995	T 1005	T 1015
15 mm			T 0996	T 1006	T 1016
20 mm			T 0997	T 1007	T 1017
15 mm	200 mm	T 0701	T 1182	T 1184	
20 mm		T 0702	T 1191	T 1185	

Material for cold processing on pages 15 - 18

Impact Aprons

Toothed profile

- special production, dimensions and rubber quality on customer request
- changeable for middle zone area
- easy mounting to any type of funnel wall

Impact aprons

Completion	Item no.
with toothed profile	T 1400
with flat profile	T 1401







NILOS

Conveyor belts

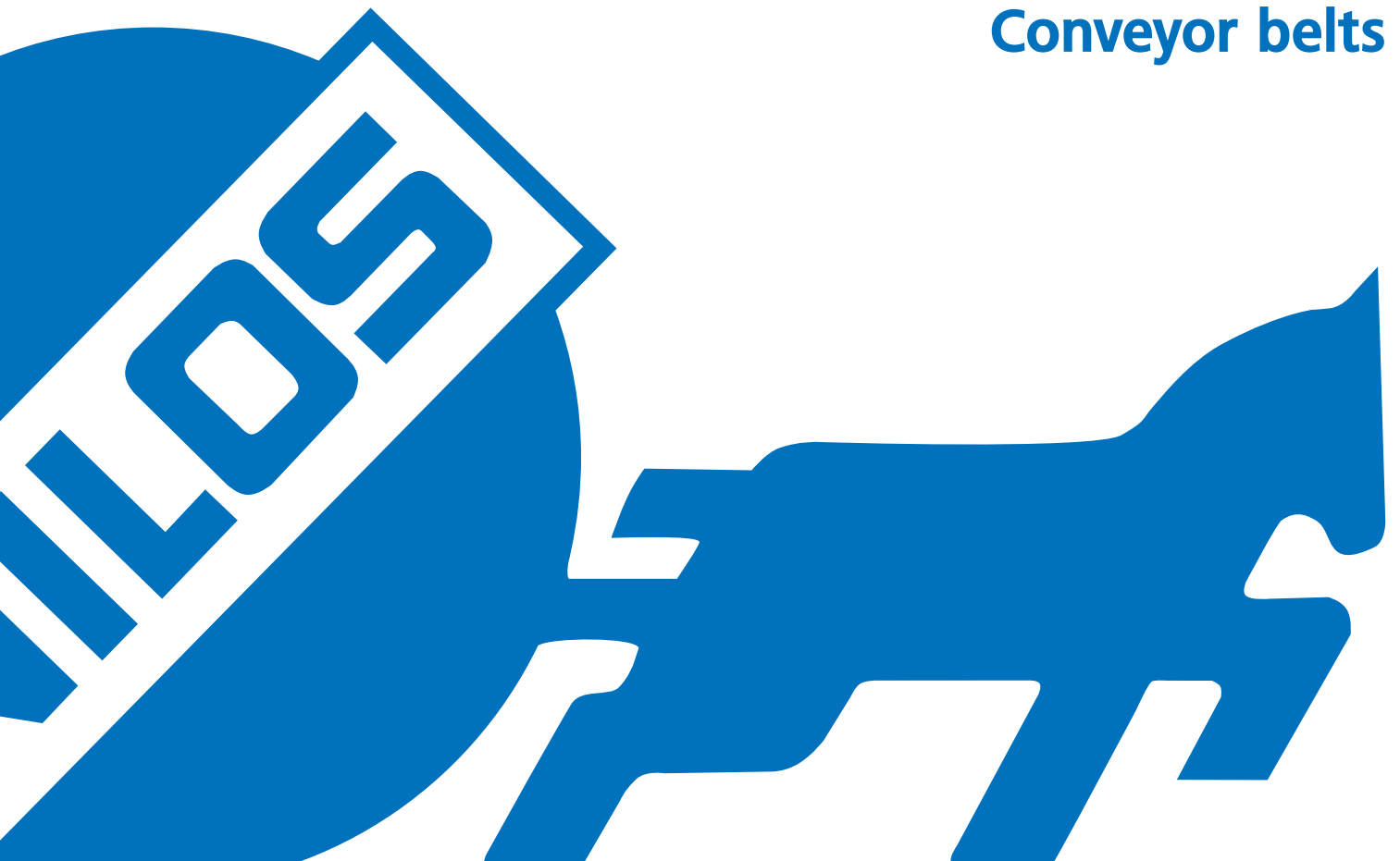

Conveyor belts

The CORD CONTROL system is a computer measuring system analysing the condition of conveyor belt splices. Its principle of operation is a precise measurement and comparison of distances between several points to determine the length of the conveyor belt splice. This allows you to select a given splice and monitor it at each conveyor belt revolution. The points defining the lengths measured are special-structure permanent magnets.

The CORD CONTROL measurement computer system comprises magnetic field sensors and a pulse-meter (measurement of the distance covered), a measuring transducer and a microprocessor which make a control system. A data transmission and processing system comprises a PC and network wiring system. The elements which define the conveyor belt measurement points are permanent magnets which are installed in a monitored belt on the opposite sides of the splices. Depending on the belt width, the magnets may be installed in two or a maximum of four places. This also limits the number of magnetic field sensors; there may be 2-4 of them. The magnets installed are of 10 mm diameter and height, thus they can be installed in any belt thicker than 12 mm.



by





NILOS

Available types and properties

- Fabric conveyor belts (EP and EE)
- Steel Cord conveyor belts (ST)
- heat resistant conveyor belts up to 200°C
- oil and grease resistant conveyor belts
- FRAS conveyor belts (self-extinguishing quality, antistatic)
- cross stabilized conveyor belts
- chevron conveyor belts
- cleated sidewall conveyor belts (elevator belts)

Standards

DIN	(German institute for standardization) (Available qualities: OR, MOR, X, Y, W, Z, K und S *)
BS	(British Standards)
NF	(Norme Francaise)
RMA	(Rubber Manufacturers Association)
JIS	(Japanese Industrial Standards)
AS	(Australian Standards)
SABS	(South African Standards)

NILOS supplies conveyor belts customized to individual application. Conveyor belts of extremely varied types have proved their suitability for use in all forms of moving goods and materials. Careful selection of suitable materials and fittings ensure a long service life and economic operation of the conveyor belt involved. We can recommend the suitable form of conveyor belt for each individual application in the handling of granulated and bulk materials whether in mining, in the chemicals or plastics industries, for loading and unloading vehicles, or to move gravel and rock.

Depending on the requirements and intended application, we can offer fabric and steel cord conveyor belts in a great variety of grades, ratings and surface properties.

Since we keep a suitable quantity of current types of conveyor belts in stock, we can ensure a high degree of availability of conveyor belts for our customers as well as short delivery times.



* Other qualities on request



Cleats for bonding on conveyor belts

Cleats are available in rubber quality **standard** or **oil- and grease-resistant**, and also with and without fabric reinforcement.

T cleat	Height	Item no.
T 20	20 mm	T 1408
T 35	35 mm	T 1411
T 40	40 mm	T 14115
T 60	60 mm	T 14125
T 80	80 mm	T 14135
T 100	100 mm	T 14145
T 110	110 mm	T 1415

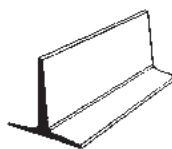

C cleat	Height	Item no.
C 35	35 mm	T 1417 *
C 60	60 mm	T 14195 *
C 80	80 mm	T 14205 *
C 110	110 mm	T 1421 *

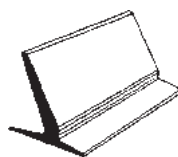

TC cleat	Height	Item no.
TC 110	125 mm	T 1425
TC 190	180 mm	T 1428

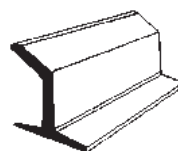

Sidewalls for bonding on conveyor belts

Sidewalls are available in rubber quality **standard** or **oil- and grease-resistant**, and also with and without fabric reinforcement.



Sidewall	Height	Item no.
K 40	40 mm	T 1430
K 60	60 mm	T 1431
K 80	80 mm	T 1432
K 100	100 mm	T 1433
K 120	120 mm	T 1434
K 140	140 mm	T 1435
K 160	160 mm	T 1436



Fabric reinforced

Sidewall	Height	Item no.
K 250	250 mm	T 1439-EP
K 300	300 mm	T 1440-EP

Material for cold processing on pages 15 - 18

Rubber Wear Protection Clamping Bars

Against noise and wear

Environmentally friendly and low maintenance installations implicate tasks that can be solved trouble-free and in a relatively easy way by using the tried and tested wear resistant rubber material. The basic properties of rubber – elasticity and abrasion resistance – enable highly efficient abatement of both noise and wear. If used correctly optimum lifetime and efficiency is guaranteed. The all-purpose rubber wear protection clamping bars bring up more possible fields of application when used in composition with NILOS wear protection coatings or NILOS screen decks.

Rubber Wear Protection Clamping Bars

Rubber wear protection clamping bars with metal inserts (see chart). While the types RU have rounded wear surfaces to ensure better guiding and protection of the conveyor belt, the types EU, EJ and ED are built with rectangular cross-sections so that they can be used side-by-side to cover wider areas. The fastening is carried out via T-bolts DIN 186 for types RU and EU; for type EJ, whose profiles bear strains of up to 12,000 kp it is carried out via special bolts.

While the aforementioned types can be fastened anywhere by clamps, the type ED 16 can also be fastened from the top in places difficult to access, as there are three precast longitudinal bores. These longitudinal bores are in intervals of 290 mm and 65 mm from the strip's edges.

Length of supply: 1.000 mm



	Type	Width x Height	kg	Item no.	Srew in mm	Item no.
1	RU 10	40 x 35 mm	2,0	T 0779		
	RU 16	60 x 47 mm	4,2	T 0780	M 10 x 30 M 10 x 60	T 0796 T 0797
2	EU 10	100 x 35 mm	4,4	T 0781	M 16 x 30	T 0798
	EU 16	100 x 50 mm	6,6	T 0782	M 16 x 50 M 16 x 80	T 0799 T 0800
	EF 10	40 x 40 mm	3,7	T 0784	M 20 x 80	T 0800
3	EF 16	60 x 60 mm	7,6	T 0785		

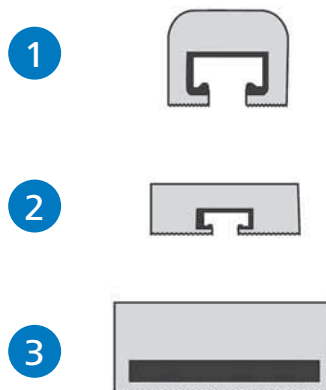



Conveyor feed point without impact bar

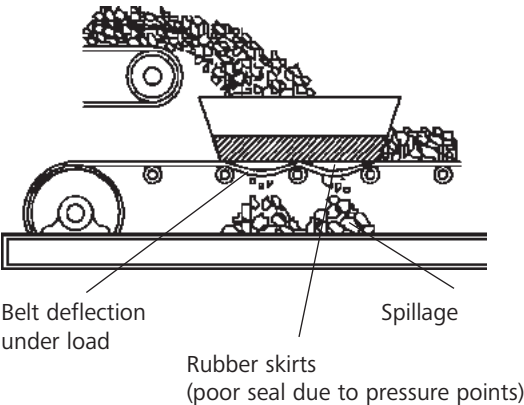

Conveyor feed point with impact bar

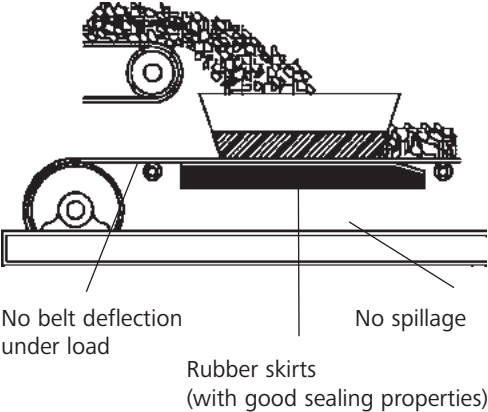

Application:

The weight of the material can cause deflection or sagging between the roller sets at the conveyor feed point. The use of rubber skirts produces a gap between the conveyed material and the rubber guide, which can cause spillage.

The consequences are:

- sticking of the material
- blocked rollers
- belt wear and damage
- belt tracking problems

Belt support at the loading area not only prevents material spillage but also increases the service life of the belt.

Characteristics:

- easy installation
- high impact and bending strength
- sliding belt Lateral
- abrasion-resistant
- shock-absorbing

Design:

- aluminum profile for quick installation with T-bolts
- shock-absorbing rubber base (core)
- surface made of polyethylene ensures low friction

Impact Bars 1.220 mm Length

Thickness x Width *	Item-no.
100 x 55 mm	T 0901
100 x 75 mm	T 0904
100 x 100 mm	T 0905

Fixing

Screw	Item-no.
M 12 x 40 mm	EK 5200042
M 16 x 40 mm	EK 5200047

- recommendation: 4 bolts per impact bar
- 1 set screws includes bolts, grommet and nut



* Other contents on request

Jet-Streamer, Pneumatic Scraper Systems

Fields of application

- contact-free cleaning of cleated and sidewall belts where conventional stripper systems cannot be used
- contact-free cleaning of smooth conveyor belt surfaces
- contact-free cleaning of wet and/or slightly adhesive, tacky materials such as e. g. sand, gypsum, slags, fine ores, etc.
- non-contact cleaning of max. 2 transfer points

Properties

- long life service
- minimum maintenance
- protection of the conveyor belt surface
- quick and simple installation
- low space requirements at the conveyor belt (only approx. 100 mm clearance under the conveyor belt required)
- available for belt widths up to 3.000 mm

Scope of supply Jet Streamer

The Jet Streamer consists of the following components:

- high-pressure radial fan
- nozzle pipe
- throttle flap
- installation materials with tube
- manual control (automatic control is available)

Properties of manual control

- splash-proof housing
- integrated protective motor switch (matching the motor power rating)
- integrated manually-switched star/delta switch (automatic control is available)

Properties of automatic control

- splash-proof housing
- integrated protective motor switch (matching the motor power rating)
- fully automatic star/delta switch, upon pressing the button once the start-up phase of the motor is automatically switched to full load
- integrated coil temperature monitor for the motor with automatic shut-off on overheating

Jet Streamer for smooth conveyor belts and conveyor belts with cleats *

Belt width	Height cleatprofile	Type	Item no.
500 mm	0 - 15 mm	JS 500/15	01266
600 - 700 mm		JS 650/15	01267
800 mm		JS 800/15	01268
1.000 mm		JS 1000/15	01269
1.200 mm		JS 1200/15	01270
1.400 mm		JS 1400/15	01271

Jet Streamer for conveyor belts with cleats *

Belt width	Height cleatprofile	Type	Item no.
500 mm	16 - 30 mm	JS 500/30	01273
600 - 700 mm		JS 650/30	01274
800 mm		JS 800/30	01275
1.000 mm		JS 1000/30	01276
1.200 mm		JS 1200/30	01277
1.400 mm		JS 1400/30	01278

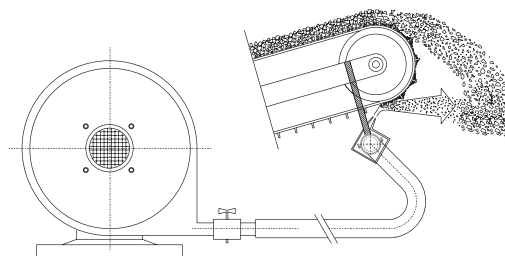



NILOS

NILOS Rollers
the roller brand



NILOS GmbH & Co. KG
 Reisholzstr. 15
 40721 Hilden • Germany
 Phone: +49 2103 951-0
 Fax: +49 2103 951-209
 info@nilos.de
 www.nilos.de

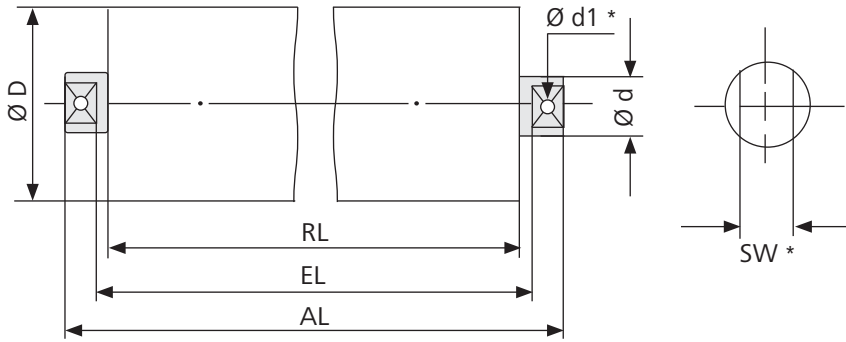

Please fill out this questionnaire as completely as possible:

1. Contact Information

Mr Mrs

Contact person _____

Phone _____

E-mail _____

Company _____

Street & no. _____

Zip Code & City _____

Country _____

Country of use _____

2. Idlers parameters

	Carryroller	Returnroller	Impactroller
Quantity	pieces	pieces	pieces
Distance frame to frame or garland to garland	m	m	m
Diameter tube Ø D	mm	mm	mm
Tubelength RL	mm	mm	mm
Shaftlength AL	mm	mm	mm
Length between frame brackets EL	mm	mm	mm
Diameter Shaft Ød	mm	mm	mm
Fit of axle end SW *	mm	mm	mm
Fot of axle end bore hole Ø d1 *	mm	mm	mm

3. Belt type

4. Place of operation

5. Belt width

Steel cord belt Underground 500 650 800 1000 1200 1400 1600 1800 2000 _____
 Textile conveyor belt Above ground 24" 26" 36" 40" 48" 54" 60" 72" 78" _____

6. Belt thickness _____ mm **7. Belt weight** _____ kg/m **8. Belt speed** _____ m/s **9. Mass flow** _____ t/m **10. Kind of bulk** _____ mm **11. Falling eight** _____ m

12. Angle of frame

Requirements

_____ ° _____

Our service for you:

- Tailor-made customer support is our strong point
- Analysis of your belt unit by our technicians
- Design of the rollers according to your requirements
- Development of customized solutions
- Our own test stands and cooperation with universities
- Support after purchase by our technicians
- Service analyses of the rollers built in

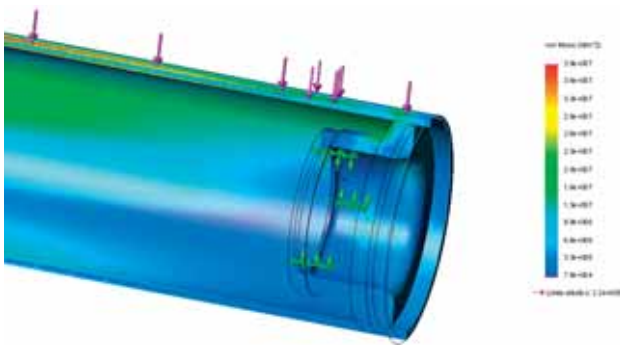

We provide the entire range for your needs.

NILOS has been the brand of your trust in the area of belt unit service and equipment since 1926. We have now completed our extensive range of products and services by adding the area of rollers.

NILOS Rollers is the new brand for rollers according to your wishes.

NILOS Rollers has a complete portfolio of rollers exactly for your application areas.

- We can provide diameters from 89 mm to 250 mm
- Made according to DIN 15207, DIN 22112 or CEMA dimensions
- Rollers available with ATEX or LOBA approval
- Available worldwide

By means of optimum production of the different rollers great cost savings are achieved. The rollers are produced according to your needs, so you do not buy any products not designed for your belt unit.

- Our products are constantly being further developed by our R&D departments
- High quality of the products due to the use of optimum materials
- Highly automated production processes with logging
- All rollers individually identification marked

Idler Laggings

Black idler lagging, type RB-R with bonding layer

Length x Width	Type	Ø Idler	Item no.
800 x 4 mm	RB-R 800/4	63,5 mm	T 1140
		80,0 mm	T 1141
		89,0 mm	T 1142
		108,0 mm	T 1143
1.000 x 4 mm	RB-R 1000/4	63,5 mm	T 1145
		80,0 mm	T 1146
		89,0 mm	T 1147
1.300 x 4 mm	RB-R 1300/4	108,0 mm	T 1148
		63,5 mm	T 1150
		80,0 mm	T 1151
		89,0 mm	T 1152
		108,0 mm	T 1153

Hose shaped, Shore 60 ± 5 Sh° A



Black idler lagging, type RX-R with bonding layer

Length x Width	Type	Ø Idler	Item no.
800 x 7 mm	RX-R 800/7	63,5 mm	T 1155
		80,0 mm	T 1156
		89,0 mm	T 1157
		108,0 mm	T 1158
1.000 x 7 mm	RX-R 1000/7	63,5 mm	T 1160
		80,0 mm	T 1161
		89,0 mm	T 1162
1.300 x 7 mm	RX-R 1300/7	108,0 mm	T 1163
		63,5 mm	T 1165
		80,0 mm	T 1166
		89,0 mm	T 1167
		108,0 mm	T 1168

Hose shaped, Shore 40 ± 5 Sh° A



Assembly sleeves

Type	Ø Idler	Item no.
TM-R	63,5 mm	T 1170
	80,0 mm	T 1171
	89,0 mm	T 1172
	108,0 mm	T 1173









NILOS

Mechanical Engineering

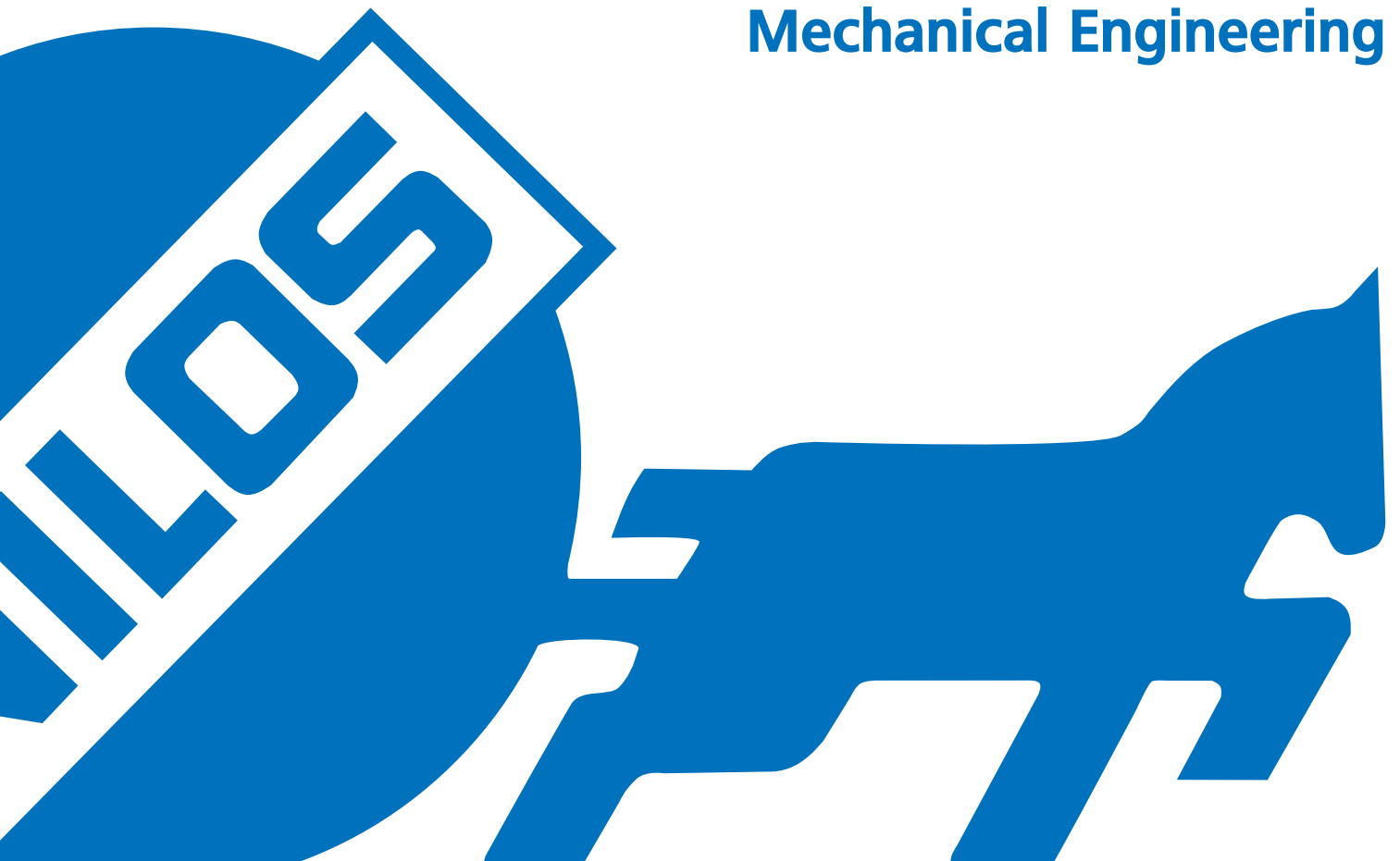

Vulcanizing Presses HYDRAULIC

Cross beams with hydraulic pressure system

- special profiles made of high-alloy aluminum
- maximum tensile and bending strength with minimum weight
- built-in protection against hose breakage, the cross beam pressure being maintained in the event of a hose breakage or a sudden pressure drop
- compact high-pressure hydraulic light metal cylinders for even surface pressure
- high quality thermal insulation made of u-shaped fibre glassreinforced polyester in the upper cross beam
- the surface area of the lower cross beam is covered with a wear-resistant insulating covering made of the same material

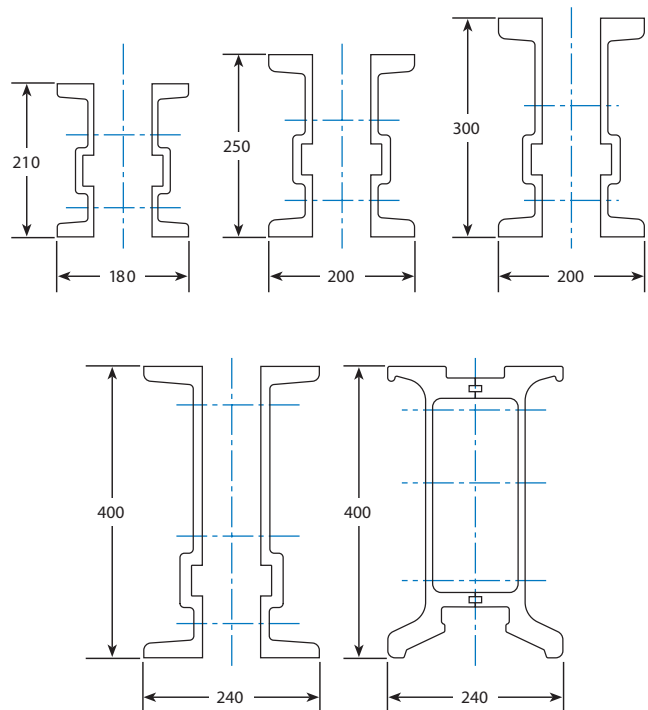

Pumps

Scope of delivery:

- reciprocating piston hand pump or motor-driven pump
- distributor
- high-pressure hoses
- hydraulic oil

Reciprocation piston hand pump

- pressure limited to 450 bar
- oil filling 8 liter (usable oil volume = 6,8 liter)
- automatic switchover from low-pressure operation to high-pressure
- pressure gauge for pressure control



Motor-driven pump unit

- pressure limited to 450 bar
- supplied complete with tubular protective frame, pressure, hose coupling and valves
- 400 V, 50 Hz *
- capacity 1,1 kW
- filling volume hydraulic oil: 17 liter or 35 liter



Hose distributor

- matches the number of cross beams

Vulcanizing Presses HYDRAULIC

Our hydraulic Vulcanizing

- robust and firm construction
- long life

Features

- high level of safety by passing traction bolts through the cross beam profile
- conventional, robust heating plates combined with hydraulic pressure systems allow splicing even on partially worn belts
- heating plate with air or water cooling
- exact temperature regulation via an electronic control box
- easier and faster pressure buildup by changing piston hand pump or motor pump unit



Vulcanizing Presses HYDRAULIC

Heating plates

- heating plates of frame-type construction, made of a high-quality corrosion-resistant aluminium alloy
- shape: rhombic 16° 42'; 22°, rectangular 90°
- optionally available with air and/or water cooling
- robust, flush fitting electrical connections guarantee safe operation
- optimum pressure and temperature distribution
- minimum temperature tolerance over the entire heating plate

Splicing by using a single heating plate (Edge zone heating) edge heating, type KH

- in order to compensate heat losses in the edge areas (edges) of the heating plates, they are provided with a greater heating capacity in the edge area than in the core area
- the heating capacity is calculated in such a way that a uniform, constant temperature can be guaranteed over the entire heating area

Edge switch, type KS

- edge zone heating can be switched on and off.
- the combination of two or more heating plates is prevented by the star knob at the edge of the heating plate
- the edge zone heating is turned off by unscrewing the star knob beforehand
- if the heating plate is to be used on its own, the star knob should be screwed in again and edge zone heating is switched on again (the heating plate can be used on its own and as a combined plate in a group)

Modular assembly of multiple small heating plates to make a splice

- using several smaller heating plates instead of just one simplifies the handling of a vulcanizing press
- an assembly of several conventional heating plates in combination can cause hot spots at the edges of two plates and damage the conveyor belt. Damage of this type is avoided by using heating plates with combination edges or edge switches

Combi-edge, type KK

- the use of heating plates in combination was taken into consideration at the design stage
- the heating capacities of adjacent edges are designed to be lower (in this case usually the heating plates are not used alone)

Vulcanizing Presses HYDRAULIC

Control box with electronic temperature control system

Each heating plate needs one output on the control box.

- electrical connection as per CEE standards
- exact temperature reading in each heating plate via thermo sensor PT 100
- electronic controller with digital display of setpoint and actual temperatures
- quick and simple programming of the electronic temperature control
- in case of electronic controller failure, manual operation is possible as well
- the controller tolerance is only about 1% of the value set (e.g.: at 145 °C, tolerance approx. 1.5 °C)
- timer
- differential monitoring of the individual heating circuits
- optional: three-phase current- or single-phase power outlet at 400 Volt.

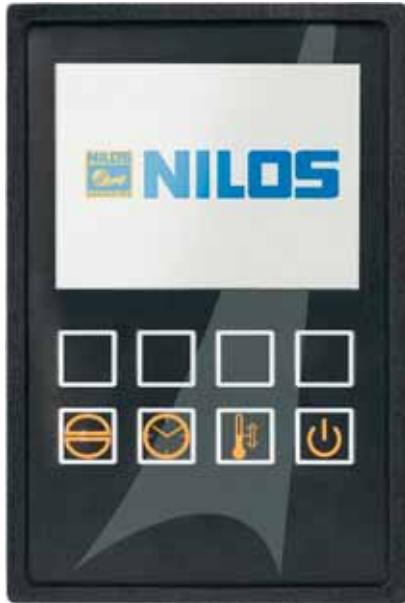

Control box	Input	Output
Double	400 V, 32 A	2 x 16 A
Fourfold	400 V, 63 A	4 x 16 A
Double	400 V, 63 A	2 x 32 A



* Other voltages on request

Vulcanizing Press with certified Pressure bag Type EMU

Heating plates

- flexible heating plates and pressure bag system adapt to the conveyor belt's top during splicing
- particularly easy to transport due to the low weight of the single parts and to the small dimensions
- constant distribution of pressure due to NILOS surface pressure system
- flexible heating plates of sandwich construction
- shape: rhombic 16° 42'; 22°, rectangular 90°
- low individual weight of heating plates

Cross Beams for pressure bag system

- light cross beams made of high-strength aluminium alloy
- maximum tensile and bending strength with minimum weight
- designed to be robust and to take up little space
- high safety standards due to insertion of the tensioning bolts with safety pins within the cross beam profile
- spacing rails for correct and secure assembly of the cross beams are included

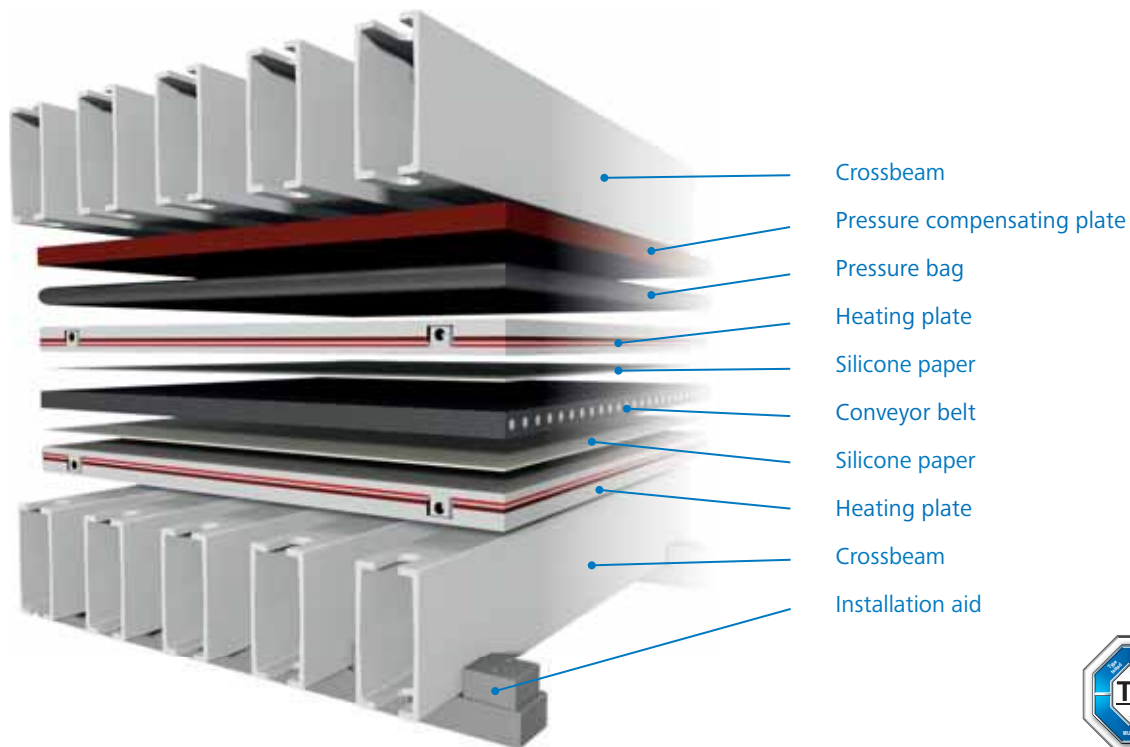
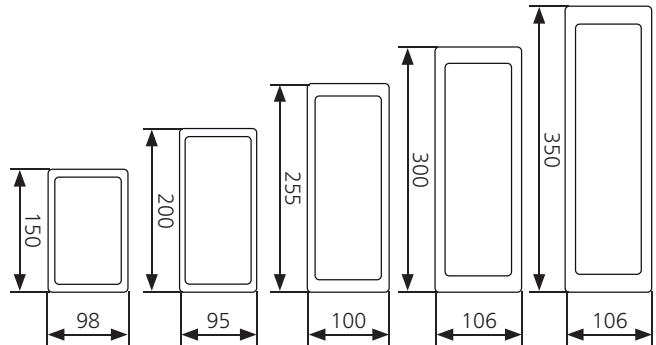

Vulcanizing Press with certified Pressure bag Type EMU

Features

- light construction for flexible use
- equipped for air or water cooling
- robust, flush fitting electrical connections with a metal plug locking device
- quick heating time with optimum heating capacity
- quick cooling time due to integrated cooling channels
- optimum pressure and temperature distribution



Vulcanizing Press with certified Pressure bag Type EMU

Certified Pressure bag

- robust rubber pressure bags with aramide reinforcement
- shape: rhombic 16° 42'; 22°, rectangular 90°
- uniform pressure by the use of pressure bags
- either air pressure or a water/glycol mixture can be used as a pressure medium
- when using air pressure surface pressure up to max. 70 N/cm² (100 psi)
- when using water/glycol mixture surface pressure up to max. 140 N/cm² (200 psi)



Various systems are available for pressure build-up

Air control box:

- surface pressure up to max. 70 N/cm² (100 psi)
- with safety valve and pressure gauge



Pressure water pumps

- pressure medium: water/glycol mixture
- pressure range: 70 - 140 N/cm² (100–200 psi)
- with safety valve and pressure gauge
- also suitable for draining pressure bags
- 400 V, 50 Hz *

Portable

- capacity: approx. 9 liter/min
- weight: approx. 25 kg
- complete with tubular frame
- additional tank (30 or 50 liter) required



- capacity: approx. 15 liter/min
- weight: approx. 54 kg
- with protection frame
- additional tank (till 50 liter) required
- compatible with SPLICE-WATCH

Mobile

- capacity: approx. 15 liter/min
- weight empty: approx. 100 kg
- tank volume: 100 liter
- complete with chassis on solid tires
- additional 100 liter tank (mobile without pump)
- compatible with SPLICE-WATCH



SPLICE-WATCH on pages 62 - 63

Vulcanizing Press with certified Pressure bag Type EMU DUO



One for two...

- one vulcanizing press for two applications
- for rectangular splicing of steel cord conveyor belts
- for rhombic splicing of fabric conveyor belts
- well-known technology combined with highest safety

Features

- flexible heating plates of sandwich construction, consisting of cooling profile, silicone heating element and insulating plate
- electronic control box with LED display
- light cross beams made of high-strength aluminium alloy
- surface hydraulic via pressure bag with aramide reinforcement

Technical data

Available

EMU Air with air control box: 70 N/cm²

EMU Liquid with pressure water pumps: 140 N/cm²

Control box on page 55

Compact Press VULCOLITE

VULCOLITE FL

Belt width	650 mm	800 mm	900 mm	1.050 mm	1.200 mm	1.400 mm	1.600 mm
Angle / bias	22°						
Heated length (A)	540 mm						
Heated width (B)	750 mm	900 mm	1.000 mm	1.150 mm	1.300 mm	1.500 mm	1.700 mm
Heated width (C) bias	810 mm	970 mm	1.078 mm	1.240 mm	1.400 mm	1.618 mm	1.830 mm
Height top	177 mm	177 mm	177 mm	194 mm	194 mm	224 mm	254 mm
Height bottom	202 mm	202 mm	202 mm	219 mm	219 mm	249 mm	279 mm
Capacity/plate	4,1 kW	4,8 kW	5,5 kW	6,0 kW	7,0 kW	8,0 kW	9,2 kW
Weight top part	63 kg	71 kg	76 kg	94 kg	108 kg	130 kg	155 kg
Weight bottom part	80 kg	88 kg	93 kg	112 kg	126 kg	148 kg	170 kg

VULCOLITE S

Belt width	650 mm	800 mm	900 mm	1.050 mm	1.200 mm
Angle / bias	22°				
Heated length (A)	350 mm				
Heated width (B)	750 mm	900 mm	1.000 mm	1.150 mm	1.300 mm
Heated width (C) bias	810 mm	970 mm	1.078 mm	1.240 mm	1.400 mm
Height top	194 mm	194 mm	194 mm	226 mm	226 mm
Height bottom	219 mm	219 mm	219 mm	251 mm	251 mm
Capacity/plate	1,6 kW	2,1 kW	2,3 kW	2,6 kW	3,1 kW
Weight top part	42 kg	46 kg	55 kg	65 kg	85 kg
Weight bottom part	50 kg	60 kg	65 kg	79 kg	97 kg

VULCOLITE SL

Belt width	800 mm	1.050 mm	1.200 mm	1.400 mm	1.600 mm
Angle / bias	22°	22°			
Heated length (A)	350 mm	350 mm			
Heated width (B)	900 mm	1.150 mm	1.300 mm	1.500 mm	1.700 mm
Heated width (C) bias	970 mm	1.240 mm	1.400 mm	1.618 mm	1.834 mm
Height top	174 mm	196 mm	196 mm	210 mm	240 mm
Height bottom	199 mm	221 mm	221 mm	235 mm	270 mm
Capacity/plate	2,1 kW	2,6 kW	3,1 kW	3,5 kW	3,9 kW
Weight top part	42 kg	57 kg	68 kg	92 kg	120 kg
Weight bottom part	57 kg	68 kg	83 kg	109 kg	140 kg

Compact Press VULCOLITE

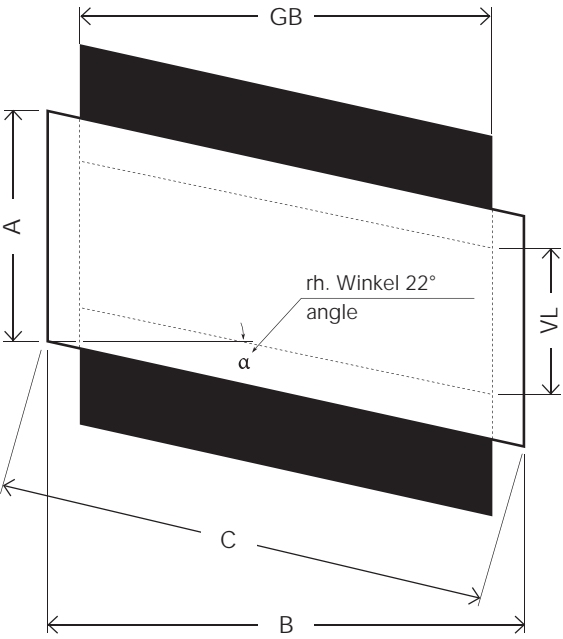

- two-piece welded aluminium frame construction
- quick assembly and disassembly

Features

- two-piece unit with silicone heating element
- sturdy Aramid reinforced pressure bag
- electronic temperature control
- adjustable temperature from 100 up to 170°C (212 - 338° F)
- incorporated air control box with safety valve
- VULCOLITE FL und VULCOLITE S: surface pressure up to max. 70 N/cm² (100 psi)
- VULCOLITE SL: surface pressure up to max. 50 N/cm² (70 psi)
- quick assembly and disassembly - for short vulcanizing cycles
- rapid heat up and cool down time
- heating plates with integrated channels for water cooling
- voltages: 230 V, 1 Phase *
- 230 V, 3 Phase+N+PE *
- 400 V, 3 Phase+N+PE *
- multiple units can be used side by side for longer splice lengths



• **VULCOLITE FL**
70 N/cm² (100 psi)
separate control box
heated length: 540 mm

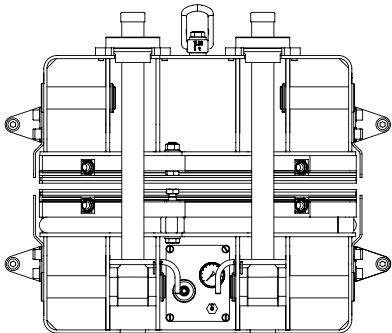

• **VULCOLITE S**
70 N/cm² (100 psi)
integrated control unit
heated length: 350 mm

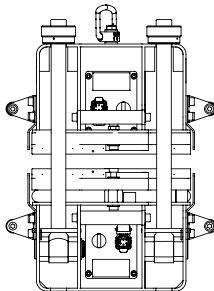

• **VULCOLITE SL**
50 N/cm² (70 psi)
integrated control unit
heated length: 350 mm
reduced height

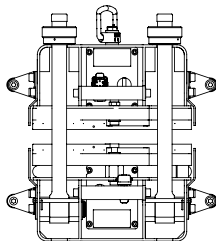

* Other voltages on request



SPLICE-WATCH

Basic

Control Box + Basic Software

Basic Software for your Laptop

- documentation and storage of the complete splicing process for up to 16 plates by using 4 control boxes
- diagram display of the complete splice data
- PDF file of the splice report for print-out
- offers transparency of the vulcanizing process
- data files for vulcanizing equipment
- data bank management of splicing equipment, splice material and splice parameter
- Windows based



SPLICE-WATCH



SPLICE-WATCH Control Box

- electronic temperature control for up to 4 plates
- LCD display for heating temperature and vulcanizing/cure time
- data logging of vulcanizing temperature, operating pressure, ambient temperature, humidity, date and time
- RF-ID (user identification)
- USB interface for data transmission

Professional

Control Box + Professional Software
for using a Laptop or Tablet

Professional Software for using a Laptop or Tablet

- live monitoring during the vulcanizing process
- documentation and storage of the complete splicing process for up to 16 plates by using 4 control boxes
- diagram display of the complete splice data
- PDF file of the splice report for print-out
- offers transparency of the vulcanizing process
- data files for vulcanizing equipment
- data bank management of splicing equipment, splice material and splice parameter
- Windows based
- WIFI Communication

Benefit from the advantage of the NILOS Software and manage your splice wherever you want.

Rugged Tablet for outdoor use for the Professional Software

- extremely bright 10.1" Touchscreen LCD with Dual Touch and Circular Polarizer
- Intel® Core™ i5-5300U vPro-Processor
- lightweight form factor - weighing only 1,1 kg
- dual hot swappable batteries providing up to 13 hours battery life
- shock-proof, waterproof and dust proof (IP65)
- USB, LAN and serial port (depends on model)
- 3MP camera with autofocus and LED (optional)
- GPS (optional)
- RF-ID (user identification - optional)
- Bluetooth
- Windows based
- WIFI Communication

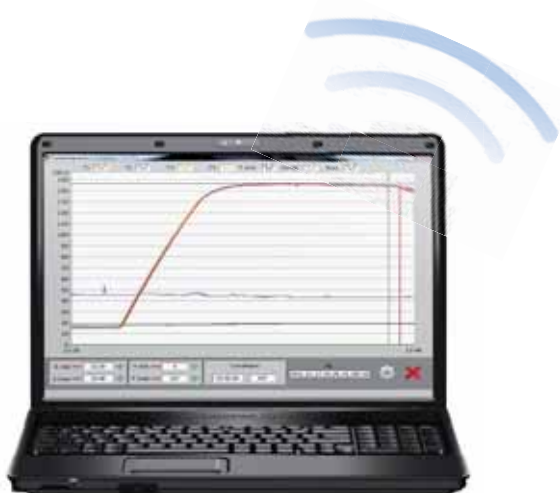

Special Vulcanizing Press VULCOFRAME

Vulcanizing press for heavy duty operation

- vulcanizing press for splicing of steel cord and fabric belts
- the “Two-Piece” vulcanizing press
- solid framework
- uniform pressure by means of pressure bags
- integrated water cooling system
- different heating systems available
- robust traction bolts for mechanical or hydraulic operation
- electronic temperature and pressure monitoring
- optional monitoring and registration of the whole vulcanizing process
- quick assembly and disassembly
- quick cooling due to water cooling
- protected pressure-bags and heating plates
- centralized connections for electricity and pressure system
- reduced downtimes
- compared to removable presses:
 - less spare parts required
 - longer service life
- customer specific technical requirements considered

The vulcanizing press VULCOFRAME is available for the following belt widths:

- 1.600 mm
- 2.000 mm
- 2.200 mm
- 2.400 mm
- 2.800 mm

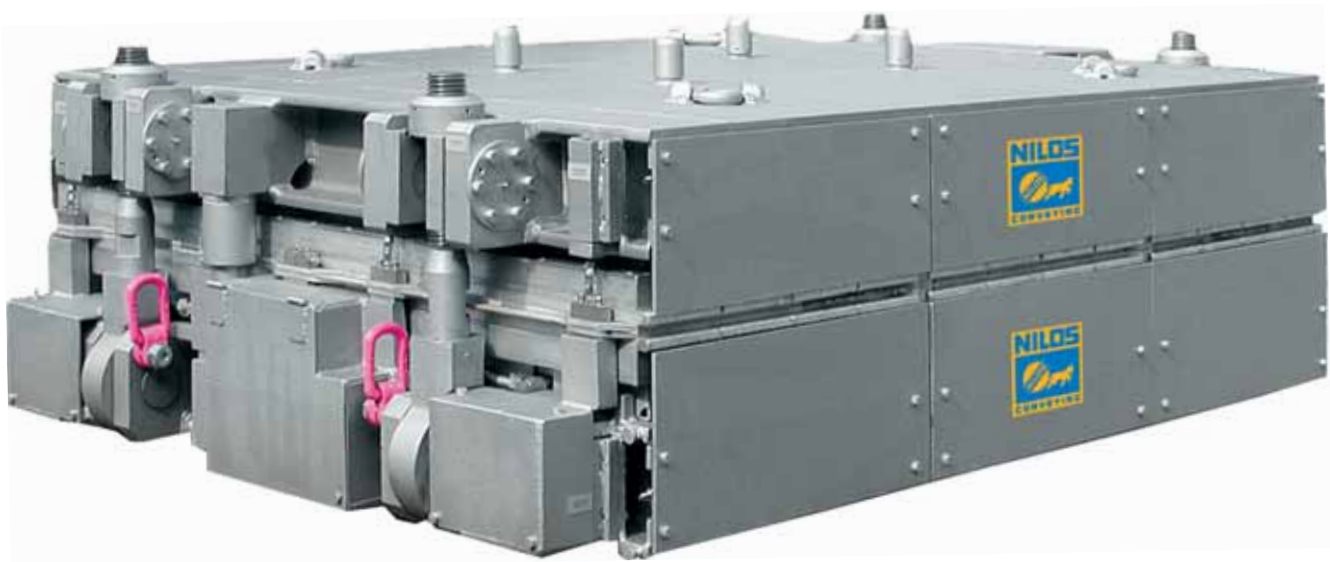

Vulcanizing Repair Press C-Clamp

Hydraulic and mechanical C-clamp for spot-, edge-, and rip-repairs

- C-clamp of high-alloy aluminium of torsion-stiff, solid welded construction
- highest bending resistance at minimum weight
- made for the following pressure power: 3 t and 6 t
- for repairing from the belt edge to the belt middle
- great depth up to the belt center, press overhang available: 200, 400, 600, 800, 1.000 and 1.200 mm
- the specific pressure achieved depends on the number of c-clamps used

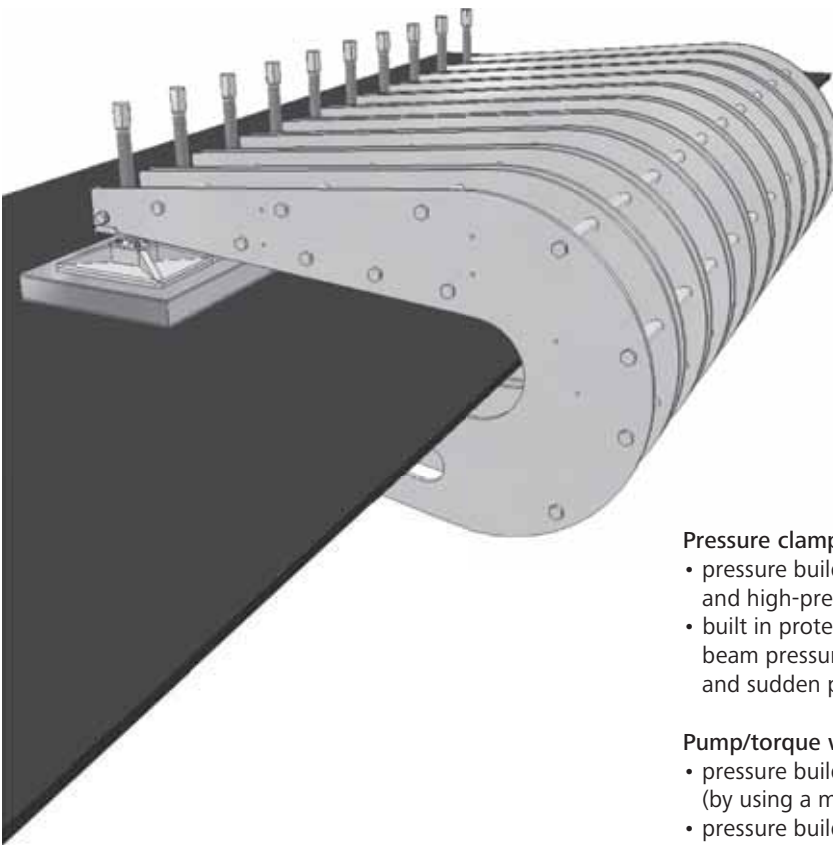

Pressure clamps with hydraulic-cylinders

- pressure build up by means of hydraulic light metal cylinders and high-pressure pump (manual or electric)
- built in protection against hose breakage (optional), the cross beam pressure is maintained in the event of hose breakage and sudden pressure drop

Pump/torque wrench

- pressure build-up by torque wrench with pressure spindles (by using a mechanical torque wrench)
- pressure build-up with hand pump (optionally motor-driven pump), distributor, high-pressure hoses and hydraulic oil

Heating plates

- in good frame construction, made of high-quality corrosion-resistant aluminium alloy
- a minimum size of 300 x 300 mm is available for spot repairs
- available for longitudinal repairs in any required length and a width of 500 mm
- specially developed heating systems and profile reinforcements guarantee optimum pressure and temperature distribution
- available with either air or water cooling
- robust and flush final electrical connections (up to 500 V, 6 pol) to ensure safe operation.

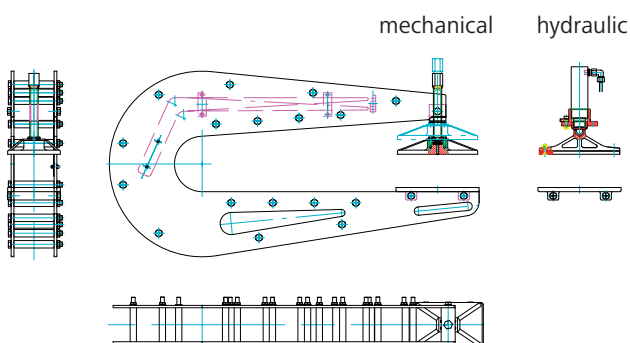

Electronic control box

- with cable connections (the configuration of the control box required depends on the number and dimensions of heating plates)
- electronic control with digital display of setpoint and actual temperatures

Longitudinal Slit Repair Presses

HYDRAULIC

Longitudinal slit repair press

- for hot splicing of longitudinal rips, punctures and damage to belt edges
- uniform pressure over the entire repair length via hydraulic aluminium cylinders
- depending on the width of the heating plates and surface pressure, cross beams are provided with 2-3 shiftable pressure elements
- for use of belt width up to 3.200 mm
- cross beam repair vulcanizing presses are designed to customer's requirements on request
- depending on the model and the size of the heating plates, cross beam repair vulcanizing presses can be used for spot and rip repairs

Repair cross beams with hydraulic cylinders

- the pressure systems can be moved over the total width of the belt

Pump

with hydraulic cross beams:

- hand pump (optionally motor-driven pump)
- distributor
- high-pressure hoses
- hydraulic oil

Heating plates

- special electrical connections
- regulation via thermosensor PT 100
- shape: rectangular 90°
- available for longitudinal repairs in any required length from min. width of 500 mm
- the number of movable beams required depends on the length of the heating plate and the required specific surface pressure

Electronic control box

- with connecting cables (number and type depends on the number and size of the heating plates)
- digital temperature display

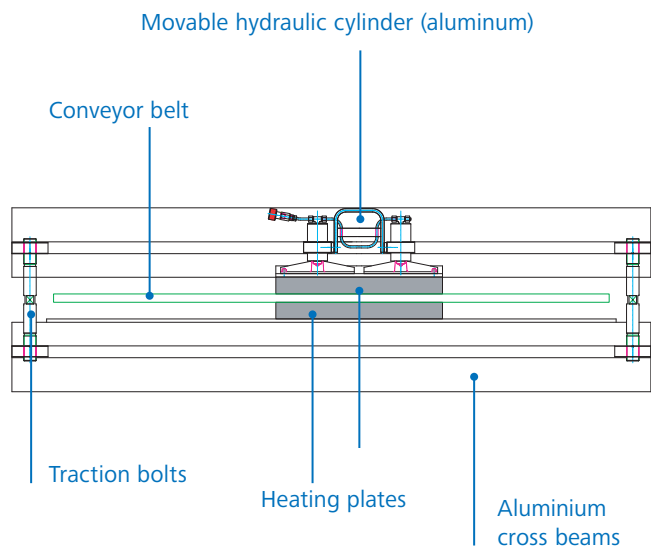

Spot Repair Vulcanizing Press EMU

Spot repair press of light weight construction

- for spot repairs on rubber conveyor belts
- for overhang of 800 mm, 1.000 mm and 1.200 mm
- particularly easy to transport due to the low weight of the single parts
- simple assembly without the need of any tools
- uniform pressure distribution by means of the pressure bag
- adjustable temperature from 100 up to 170° C

Heating plates

- heating plates can be disassembled for transport and stored in the transport box
- heating plates with electronic temperature control, signal lamp and digital temperature display
- water-/air-cooling

Transport box for heating plates

- transport box for heating plates with integrated air control box, easy to handle

C-Clamp

- C-Clamp of high-alloy aluminium, solid welded construction
- highest bending resistance at minimum weight
- press overhang available: 800 mm, 1.000 mm and 1.200 mm

Compressed air supply

- compressed air is regulated by an integrated air control box with safety valve and an easy to read pressure gauge
- connections and indicating instruments are easily reached from the top
- compressed air to be supplied by the customer
- optionally a light weight compressor can be supplied

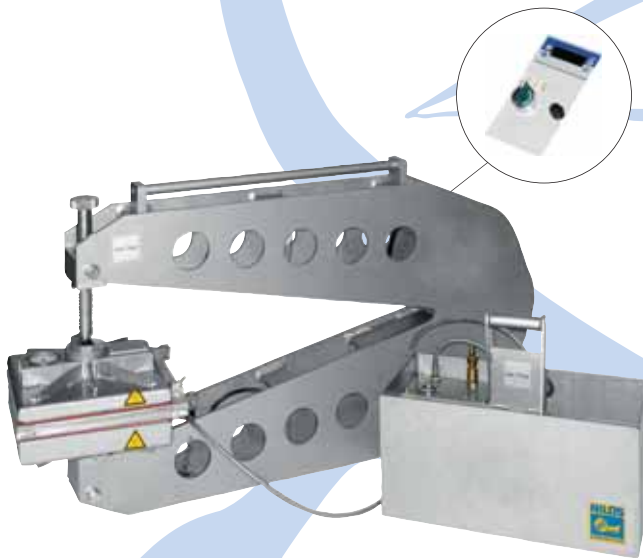

EMU	800	1.000	1.200
Overhang	800 mm	1.000 mm	1.200 mm
Opening of jaw		110 mm	
Weight C-Clamp	40 kg	54 kg	67 kg
Weight per heating plate		8 kg	
Weight transport unit		10 kg	
Specific surface pressure	50 N/cm ² (70 psi)		33 N/cm ² (47 psi)
Heating area	300 x 300 mm		
Temperature range	100 - 170 °C		
Voltage	230 V 50 Hz, 1 Ph, N, PE *		
Capacity	1,2 kW		
Compressed air supply	to be provided by Customer		
Cooling media	Air		

* Delivery option also in 110 V

ROTOCUT

ROTOCUT RCM 20

Technical data

- belt thickness up to 20 mm
- Ø steel cord up to 7,5 mm (ST2500)
- manual drive
- carrying side max. 9 mm
- running side max. 5 mm
- weight: 45 kg



ROTOCUT RCE 20

Technical data

- belt thickness up to 20 mm
- Ø steel cord up to 7,5 mm (ST2500)
- capacity 0,55 kW, 400 V, 50 Hz, 3 Ph *
- cutting speed 1,20 m/min
- carrying side max. 9 mm
- running side max. 5 mm
- weight: 65 kg



ROTOCUT RCE 40

Technical data

- belt thickness up to 40 mm
- Ø steel cord up to 11 mm (ST5400)
- capacity 1,10 kW, 400 V, 50 Hz, 3 Ph *
- cutting speed 1,10 m/min
- carrying side max. 19 mm
- running max. 10 mm
- weight 165 kg
- emergency stop



ROTOCUT

- safe cutting / separating of steel cord conveyor belts
- cutting tools can be easily replaced
- portable device for easy and rapid use in the field
- the working direction can be corrected when guiding the device manually (in case of electric drive simply by pressing the switch)
- a guide rail is not required



Cord Stripper System

1 Cord stripper

The Cord Stripper is an indispensable accessory to strip and separate the steel cables of conveyor belts.

Technical details	Item no.
Cord stripper	K 1200
• belt thickness up to 43 mm	
• Ø cable 3,7 - 12,6 mm	
• cord width 10 - 25 mm	
• cover plate thickness running side till 25 mm	
• cover plate thickness carrying side till 12 mm	
• dimension (L x H x W) 375 x 215 x 405 mm	
• weight 12 kg	
• 1 blade holder set type A + pressure roller	
• 1 blade holder set type B + pressure roller	
• 1 tool set	
1 blade holder set type A + pressure roller	K 1210
1 blade holder set type B + pressure roller	K 1220
1 tool set	K 1230



2 Blades for cord stripper

The minimum order quantity of each blade is 50 pieces (O = Top and U = Bottom). Blades are not part of the delivery of the cord stripper and must be ordered separately.

Blade no.	Blade holder	Cable Ø	Item no.
4,5		3,7 - 4,1 mm	K 1045-O /-U
5		4,2 - 4,6 mm	K 1050-O /-U
5,5		4,7 - 5,1 mm	K 1055-O /-U
6		5,2 - 5,6 mm	K 1060-O /-U
6,5		5,7 - 6,1 mm	K 1065-O /-U
7	A	6,2 - 6,6 mm	K 1070-O /-U
7,5	A	6,7 - 7,1 mm	K 1075-O /-U
8	A	7,2 - 7,6 mm	K 1080-O /-U
8,5	A	7,7 - 8,1 mm	K 1085-O /-U
9	A	8,2 - 8,6 mm	K 1090-O /-U
9,5	A	8,7 - 9,1 mm	K 1095-O /-U
10	A	9,2 - 9,6 mm	K 1100-O /-U
10,5	A	9,7 - 10,1 mm	K 1105-O /-U
11	A	10,2 - 10,6 mm	K 1110-O /-U
11,5	B	10,7 - 11,1 mm	K 1115-O /-U
12	B	11,2 - 11,6 mm	K 1120-O /-U
12,5	B	11,7 - 12,1 mm	K 1125-O /-U
13	B	12,2 - 12,6 mm	K 1130-O /-U

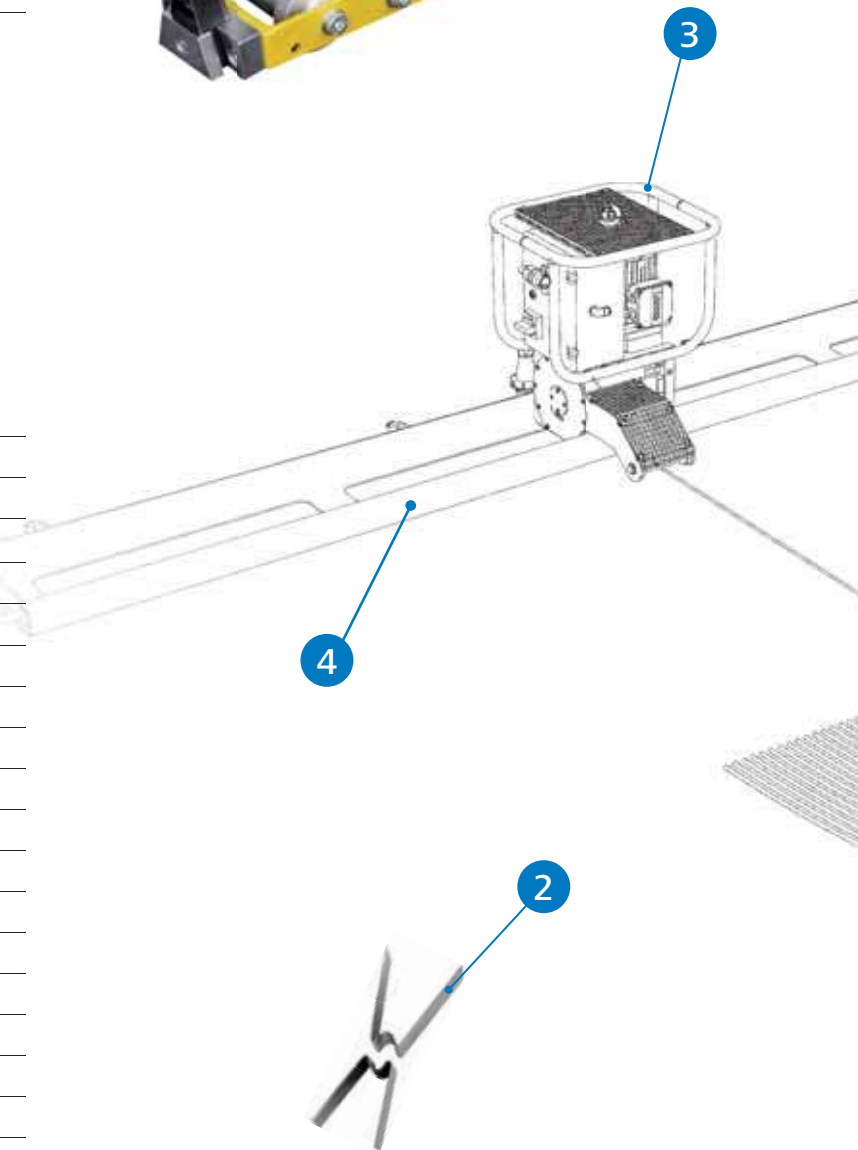



Capacity winch CS

The power winch CS is an indispensable part of the cord stripper System. It is specially designed for continuous use and is especially characterized by high tensile speed, the torque and the nearground cable conduit. In addition, the signal color contributes to workplace safety. The safe operation of the supply and return takes place (4m long) via the control panel with emergency stop switch.

The electronic phase control ensures that the operation of supply and return is always consistent.

Technical Details

Item no.

Capacity winch CS

on request

- rope made of steel 6 m
- remote control 4 m
- power 2,20 kW, 400 V, 50/60 Hz, 3 Ph + PE *
- dimensions (L x H x W) 620 x 500 x 650 mm
- protection type IP 54
- weight approx. 70 kg
- tensile speed: approx. 38 m/min.
- overload protection

Rope made of steel 10 m

K 1310

4

Slide rail for Capacity winch CS

The slide rail is fixed transversely to the conveyor belt and is used to safely accommodate the Capacity winch CS. By gently moving the Capacity Winch within the guide rail, the optimum position for the pulling direction is assured.

Technical Details

Item no.

Slide rail for Capacity winch CS

K 1316

- length 3,5 m
- with fixing points for belt width up to 3.000 mm
- dimensions (L x W x H) 3.500 x 380 x 70 mm
- weight 60 kg

Order example:

To use the cable stripper system for the first time, you need the following components:

- cord stripper
- min. 50 x blades (top) for cord stripper
- min. 50 x blades (bottom) for cord stripper
- power winch CS *
- slide rail for Capacity Winch CS

Current movies can be found at:
www.nilos.de

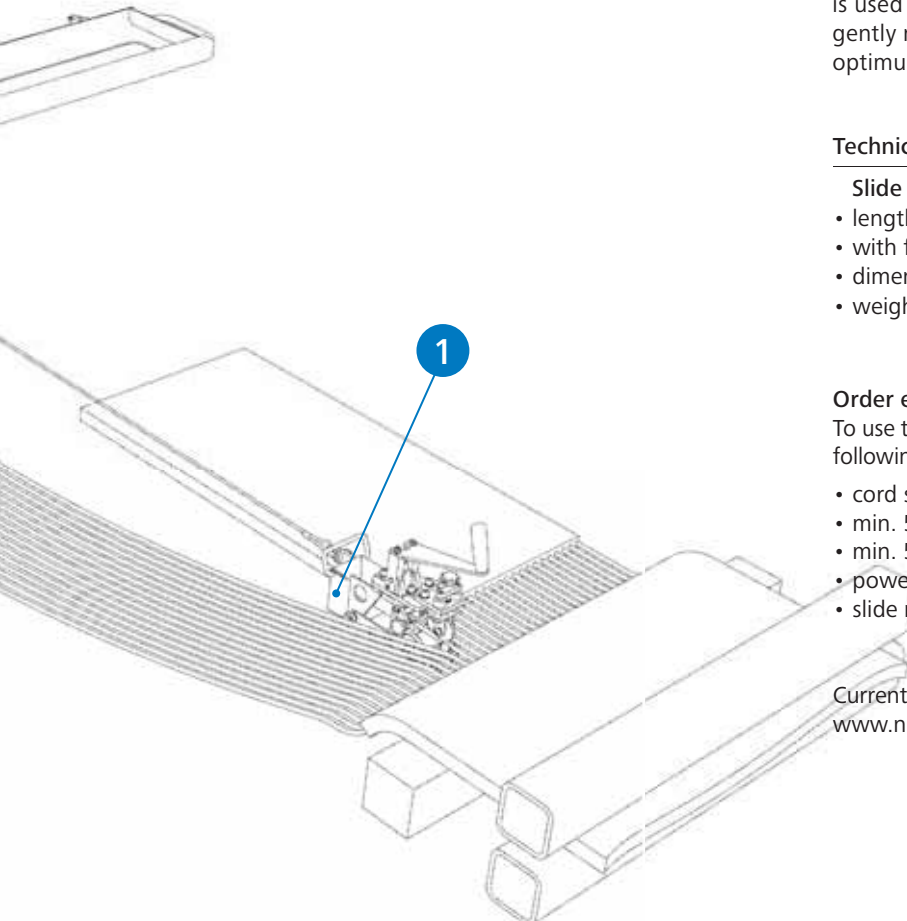

Belt Ripper

The Belt Ripper is intended for the cutting of conveyor belts of all assembly types and strengths, in particular of steel cord belts. The ripping cut is made at right angles to the belt running direction.

The Belt Ripper is intended for stationary and mobile use. In the case of stationary use, the belt clamping frame is opened in parallel and the conveyor belt is pushed into the belt clamping frame. In the case of mobile use, the belt clamping frame suspended from the crane is opened scissors-like and moved into the belt conveyor.

Alternatively the belt clamping frame standing on the ground with mounted wheelsets can be opened scissors-like and moved into the belt conveyor. For this purpose a rail track is to be provided by the customer.

The Belt Ripper consists of the following components:

- Belt clamping frame
- Electrical switch cabinet
- Hydraulic unit

Current movies can be found at:
www.nilos.de

Dimensions without control unit

Width	approx. 960 mm
Height	approx. 1750 mm
Length	approx. 2600 mm + belt width

Technical data

Service voltage *	DS 400 V, 50 Hz
Driving power, ripping knife	2,2 kW
Driving power, pump motor	3,0 kW
Max. belt width	up to 3200 mm
Max. belt thickness	up to 50 mm
Ripping time for belt width of 3200 mm	approx. 140 sec.

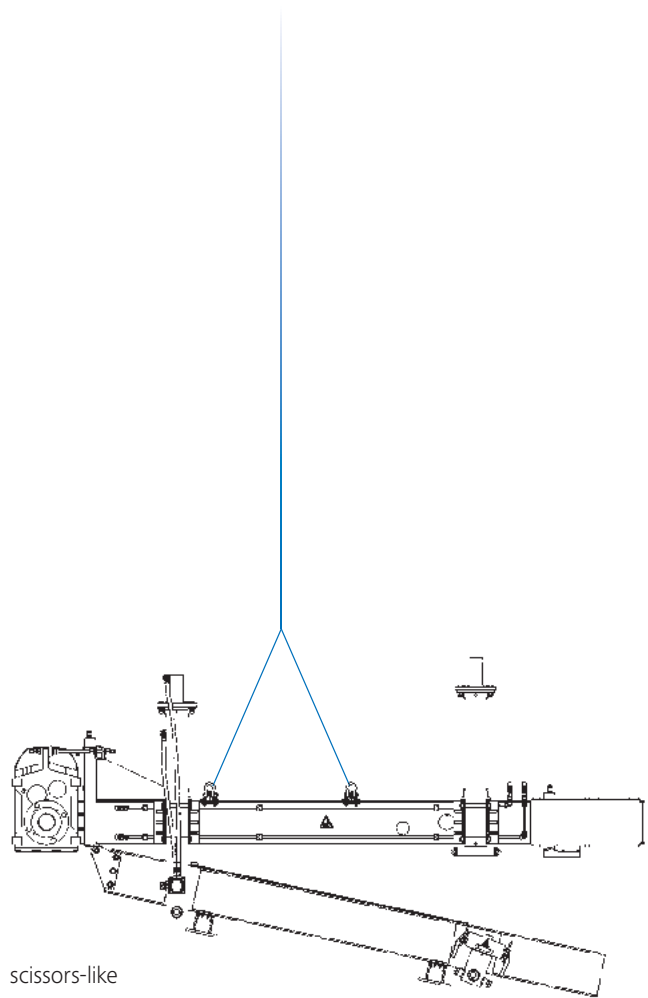

scissors-like

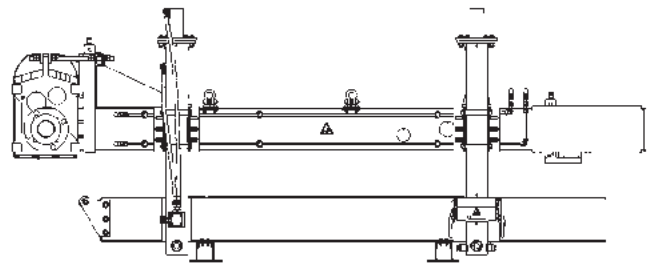

parallel

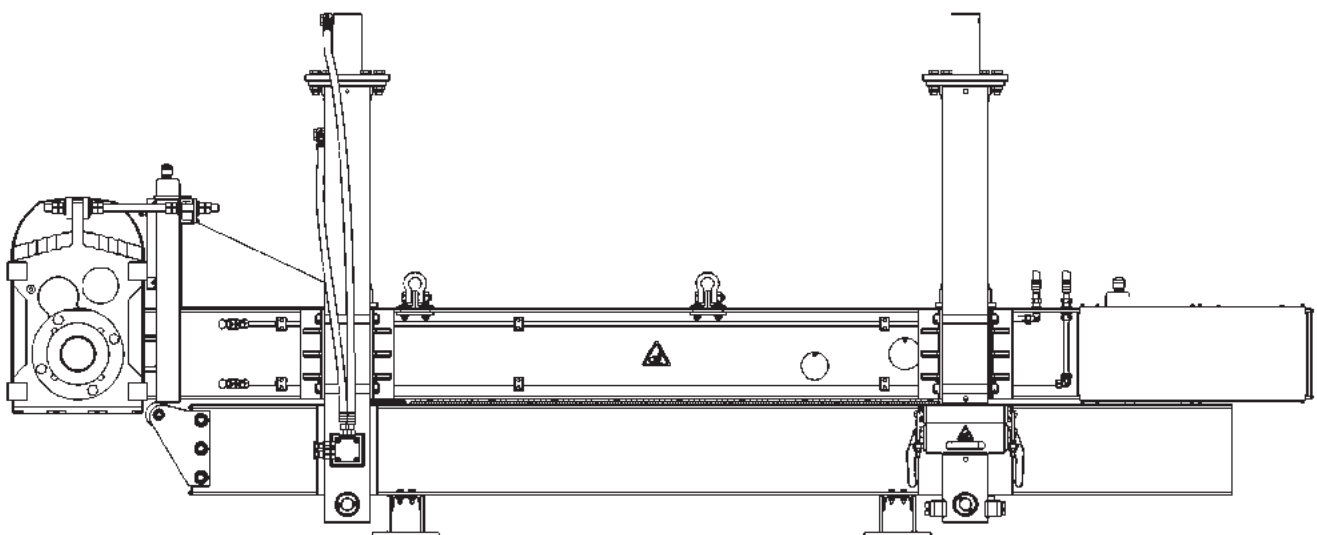







NILOS

Tools

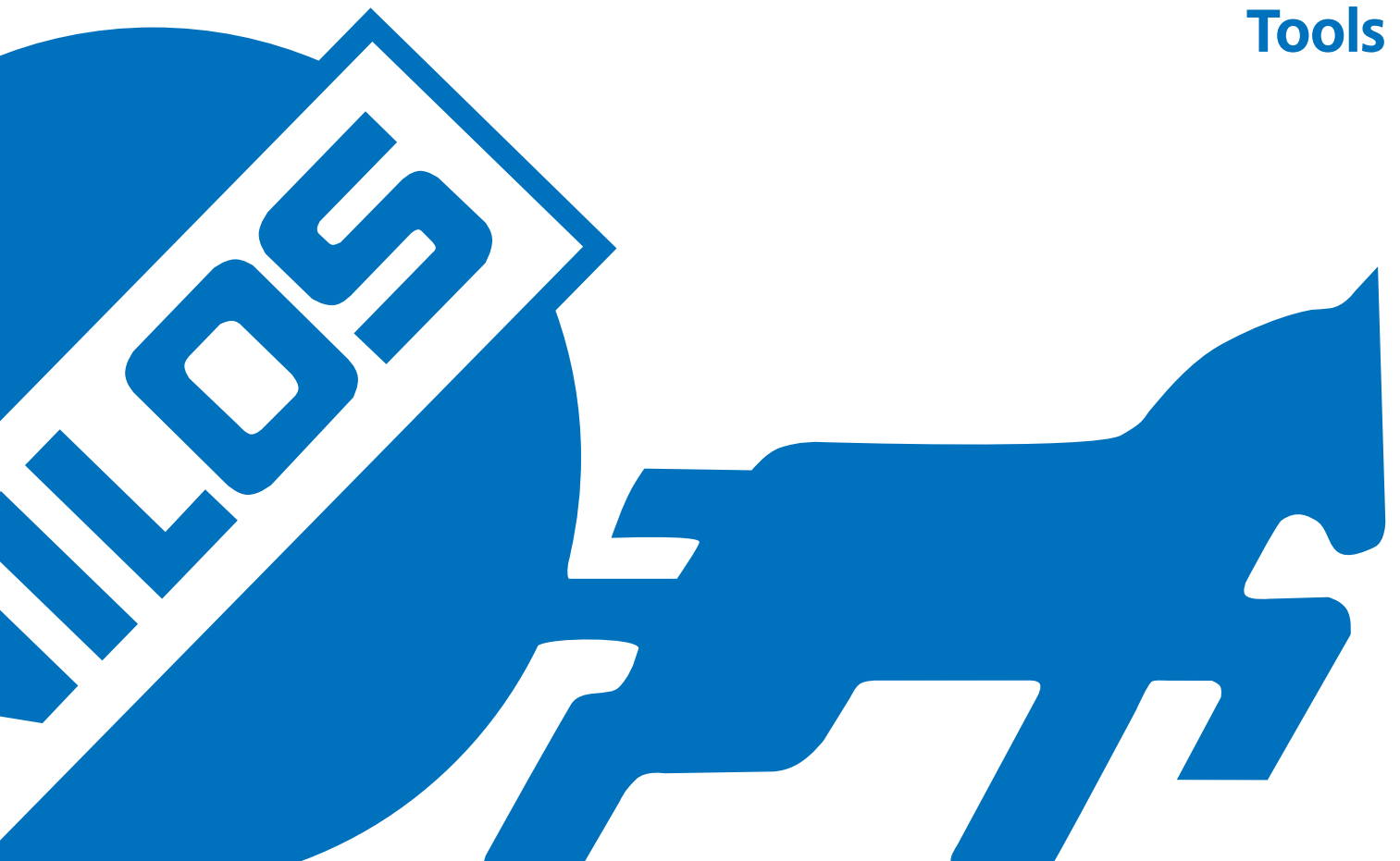

Screw Terminals and Belt End Clamps

Belt End Clamps (1 Pair) in light metal construction for tightening the belt ends

Max. belt width	Type	Item no.		
800 mm	EL 800	E 0183		
1.000 mm	EL 1000	E 0184		
1.200 mm	EL 1200	E 0185		
1.400 mm	EL 1400	E 0186		
1.600 mm	EL 1600	E 0187		
1.800 mm <td EL 1800	E 0188	2.000 mm	EL 2000	E 0193
2.000 mm	EL 2000	E 0193		

- with hand screws (max. 40 kN)
- clamping range 5 - 30 mm



Belt End Clamps (1 Pair) in light metal construction for tightening the belt ends

Max. belt width	Type	Item no.
1.200 mm	ELC 1200	E 0200
1.400 mm	ELC 1400	E 0201
1.600 mm	ELC 1600	E 0202
1.800 mm	ELC 1800	E 0203
2.000 mm	ELC 2000	E 0204
2.200 mm	ELC 2200	E 0205
2.400 mm	ELC 2400	E 0206
3.200 mm	ELC 3200	E 0207

- with hand screws and deflection compensator (max. 50 kN)
- variable clamping range



Clamps for Edge Rails (1 Pair), adjustable for different belt widths

Max. belt width	Type	Item no.
500 - 1.000 mm	JKS 50	J 0478
1.000 - 1.400 mm	JKS 100	J 0479
1.400 - 1.800 mm	JKS 140	J 0480
1.800 - 2.200 mm	JKS 180	J 0513
2.200 - 2.600 mm	JKS 220	J 0515
2.600 - 3.000 mm	JKS 260	J 0517



Clamps for Edge Rails (1 Pair)

Max. belt width	Type	Item no.
all belt widths	UNI	J 0600

- adjustable for various belt widths



Cable Winch, Ratchet Hook, Rope Block



- totally enclosed automatic brake
- 1.5 m travel



Cable winch, 20 m

Traction power	Type	Item no.
500 kg	EM 55 Motor driven 400 V 50 Hz 3 Ph	E 0191
980 kg	EM 100 Motor driven 400 V 50 Hz 3 Ph	E 0194
800 kg	EG 8A	E 0190
1.600 kg	EG 16A	E 0208
3.200 kg	EG 32A	E 0209

Traction cable for cable winch with load hook, 20 m

Cable diameter	Suitable	Item no.
8,4 mm	EG 8 A	E 0190-1
11,5 mm	EG 16 A	E 0190-2
16,0 mm	EG 32 A	E 0190-3

Ratchet hook with chain galvanized (round) steel chain,

Traction power	Chain length	Type	Item no.
750 kg	1,7 m	ER 750	E 0300
1.500 kg	1,7 m	ER 1.500	E 0301
3.000 kg	1,8 m	ER 3.000	E 0302
6.000 kg	3,6 m	ER 6.000	E 0303
9.000 kg	5,3 m	ER 9.000	E 0304

Rope block for doubling traction power

Traction power	Type	Item no.
Max. 2.000 kg	ESF 16 for EG8A/EM 55	E 0192
Max. 5.000 kg	ESF 40	E 0195

Tool Bag

Leather tool bag

Description	Item no.
Tool bag without tools	K 0659

- with hand grip and adjustable shoulder strap
- padlocks
- size: approx. 460 x 240 x 180 mm

Leather tool bag incl. Tools

Description	Item no.
Tool bag with tools	K 0665
Weight approx. 9 kg	

The set included the following tools:

Knife, simple with a short blade
Blade length 150 mm
2x Cobblers knife with exchangeable blade
Spare blade for Cobblers knife
Layer separating knife
Knife with flexible blade
Angled knife
Quarter moon knife
Whetstone with wooden haft, 100 x 25 x 10 mm
Curled roller, 4 mm wide
Spiked roller, 27 x 52 mm
Flachroller, 12 mm wide
Flat roller, 40 mm wide
Hohlroller, 12 mm breit
Roughening brush with pad
3x Spare pad for Roughening brush
Wire brush
Rubber shears 100 mm
Pliers, Length 200 mm
Screwdriver 175 x 10 mm
Stripping hook 150 mm length
Folding rule 2 m
Round brush size 4
Round brush size 12
Handbrush
Rubber hammer
Belt grips for belts up to 21 mm thick
Tape measure 2 m length
Protective spectacles
Marking cord with chalk dust container
Chalk line Powder, yellow, 180 g
Industrial gloves
Packet of white chalk, 1 VPE = 12 pieces
Yellow grease pencils, 1 VPE = 12 pieces





Canvas rollbag

Description	Item no.
Canvas rollbag without tools	K 0700
<ul style="list-style-type: none"> with leather strap size: approx. 540 x 330 mm 	

Knife	Item no.
With short blade, simple	K 0601
With long blade, simple	K 0602

Saddlers knife	Item no.
Blade length 150 mm / 6"	K 0604
Blade length 200 mm / 8"	K 0744

Cobblers knife	Item no.
With exchangeable blade	K 0605
Spare blade	K 0606

	Item no.
Layer separating knife	K 0607

	Item no.
Knife with flexible blade	K 0608

	Item no.
Angled knife	K 0609

	Item no.
Quarter moon knife	K 0610

Whetstone, with wooden haft	Item no.
100 x 25 x 10 mm	K 0611
200 x 25 x 10 mm (and groove)	K 0634

Curled roller	Item no.
4 mm wide	K 0612

Spiked roller	Item no.
27 x 52 mm	K 0613

Small Tools

Stripping hook	Item no.
150 mm length	K 0623

Flat roller	Item no.
12 mm wide	K 0614
40 mm wide	K 0615

Roughening brush	Item no.
With pad	K 0617
Spare pad	K 0618

Wire brush	Item no.
Wire brush	K 0619

Rubber shears	Item no.
100 mm	K 0620

Pliers	Item no.
Length 200 mm	K 0621
Length 300 mm	K 0745

Screwdriver	Item no.
175 x 10 mm	K 0622

Concave roller	Item no.
12 mm wide	K 0616

Round brush	Item no.
Size 4	K 0625
Size 12	K 0626

Handbrush	Item no.
Handbrush	K 0627

Rubber hammer	Item no.
Rubber hammer	K 0628



- for marking and cutting the angle of splice



- 338 x 90 mm
- weight 1,1 kg
- temperature 40 - 650° C
- air consumption max. 320 Liter/min



Belt Square

Belt width	Type	Item no.
800 mm	JW 80	J 0481
1.000 mm	JW 100	J 0482
1.200 mm	JW 120	J 0483
1.400 mm	JW 140	J 0484
1.600 mm	JW 160	J 0485
1.800 mm	JW 180	J 0486

Heat Blower

Capacity	Voltage	Item no.
2.700 W	110 V/60 Hz	K 0699
3.400 W	230 V/50 Hz	K 0698

Double acting roller

Belt width	Item no.
800 mm	K 0642
1.200 mm	K 0643
1.600 mm	K 0644
2.000 mm	K 0676



Frog clamps

Traction power	Weight	Item no.
300 kg	2,3 kg	K 0754
1.000 kg	2,4 kg	K 0646
1.000 kg	5,7 kg	K 0760



Belt grips

Item no.
For belts up to 13 mm thick
For belts up to 21 mm thick

- to remove bonded rubber strip



Tear-out claw

Item no.
Tear-out claw

Small Tools

Shore hardness gauge	Item no.
Shore hardness gauge	K 0652



Conveyor belt measuring device (meters)	Item no.
Conveyor belt measuring device (meters)	K 0648



Belt thickness gauge	Item no.
Measuring range 0 - 30 mm	K 0660



Thermometer for heating plates	Item no.
Glass-thermometer	K 0653



Bimetal dial type thermometer	Item no.
2 off in protective case	K 0655

- for heating plates



Digital thermometer	Item no.
With heat sensor and box	K 0771
Digital thermometer	K 0771-A
Box	K 0771-B
Sensor 130 mm, Ø 3 mm cable 1.200 mm	K 0771-C
Sensor 130 mm, Ø 3 mm cable 2.500 mm	K 0771-D
Adapter 130 mm	MZ 027017

- measuring range: - 50° C to + 1.150° C
- for mutual connection of 2 exchange sensors (NiCrNi)



Small Tools



Folding rule	Item no.
2 m	K 0624



Tape measure	Item no.
2 m length	K 0657
5 m length	K 0657-A
20 m length	K 0656



Chalk line powder	Item no.
Marking cord with chalk dust container	K 0661
Powder, yellow, 180 g	K 0661-A



Screw clamp	Item no.
Screw clamp	K 0654



Industrial gloves	Item no.
Industrial gloves	K 0662



Protective spectacles	Item no.
Protective spectacles	K 0658



Packet of white chalk	Item no.
1 VPE = 12 pieces	K 0663
Yellow grease pencils	Item no.
1 VPE = 12 pieces	K 0664

Handextruder on page 21

Rubber Cutting Machine

Electrical rubber cutting machine with
1x HSS Ø 170 mm, maximum thickness up to 25 mm

Capacity	Weight	Item no.
580 W, 230 V, 50 Hz	7 kg	K 0782
18 V, 3,0 Ah, 230 V, 50 Hz with 2 batteries, charger	8 kg	K 0782-C
Replacement circular saw blade HSS Ø 170 mm		K 0782-M

Electrical rubber cutting machine with
1x HSS Ø 225 mm, maximum thickness up to 50 mm

Capacity	Weight	Item no.
580 W, 230 V, 50 Hz	13 kg	K 0783
Replacement circular saw blade HSS Ø 225 mm		K 0783-M

Pneumatic Rubber Cutting Machine with 1x HSS
Ø 220 x 2 mm, maximum thickness up to 50 mm

Capacity	Item no.
4-6 bar, 30 rpm	K 0737
Replacement circular saw blade HSS Ø 220 x 2 mm	K 0738

Rubber stripper complete with transport box,
1 cutter, toolkit, protective gloves

Capacity	Weight	Item no.
1050 W, 230 V, 50 Hz*	9,1 kg	K 0763
Blades 120 x 1 mm, 1 VPE = 10 pieces		K 0764
Blades 200 x 1 mm, 1 VPE = 10 pieces		K 0765

Easy Cut

Capacity	Weight	Item no.
18.500 rpm, 400 W, 230 V, 50 Hz	4 kg	K 0781
Blades, 1 VPE = 2 pieces		EK 6600455

- shore hardness 25 - 90 Sh° A
- pneumatic version on request



- electrical knife for cutting steel cord plates





- cutting head with clamping width segmented cutting from 2 to 28 mm



Regroover

Mains supply circuit for connected operating handle	Weight	Item no.
230 V, 50 Hz	11,5 kg	K 0678
115 V, 50Hz	11,5 kg	K 0678-A
Operating handle for coupling mains supply circuit, 2 m Cable		
cutting head with clamping width segmented cutting from 2 to 28 mm	1,5 kg	K 0677
Regroover complete: K 0678 and K 0677		K 0679

Compact-Regroover with three-step switch

Capacity	Weight	Item no.
230 V, 50 Hz	1,8 kg	K 0680
115 V, 50Hz	1,8 kg	K 0680-A

Regroover blades for regroover

Round		
Cutting width	Cutting depth	Item no.
2 - 4 mm	7 mm	K 0681
4 - 6 mm	8 mm	K 0682
6 - 8 mm	10 mm	K 0683
8 - 10 mm	14 mm	K 0684
10 - 14 mm	16 mm	K 0685
Angle		
2 - 4 mm	7 mm	K 0686
4 - 6 mm	8 mm	K 0687
6 - 8 mm	10 mm	K 0688
8 - 10 mm	14 mm	K 0689
10 - 14 mm	16 mm	K 0690
V-shaped		
2 - 4 mm	7 mm	K 0691
4 - 6 mm	8 mm	K 0692
6 - 8 mm	10 mm	K 0693
8 - 10 mm	14 mm	K 0694
10 - 14 mm	16 mm	K 0695
16 - 22 mm	16 mm	K 0696
22 - 28 mm	16 mm	K 0697

Roughing Machine

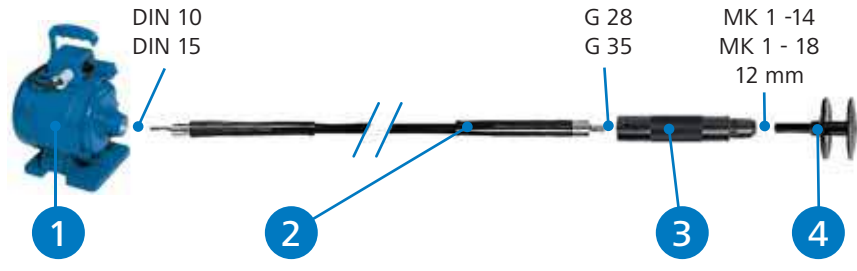

1

Roughing machine with base plate and carrying handle

Capacity	Coupling	Weight	Item no.
1.000 W, 400 V, 50 Hz 2.800 rpm	DIN 10	10,8 kg	K 0706
1.500 W, 400 V, 50 Hz 2.800 rpm	DIN 15	13,9 kg	K 0703



Scope of delivery:

- Flexible shaft by [K 0706](#): DIN 10 / G 35: [K 0710](#)
- Flexible shaft by [K 0703](#): DIN 15 / G 35: [K 0711](#)
- Toolholder: G 35 / MK 1-14: [K 0713](#)
- Overhung spindles, MK 1-18: [K 0715](#)

2

Flexible Shafts for Roughing machine 2.000 mm Length

Ø Core	Coupling	Weight	Item no.
12 mm	DIN 10 / G 28	3,75 kg	K 0748
	DIN 10 / G 35		K 0710
	DIN 15 / G 35	3,85 kg	K 0711
15 mm	DIN 15 / G 35	5,25 kg	K 0712

Scope of delivery: Consisting of shaft with rubber protective casing with reinforcing sleeves and outer metal couplings



3

Toolholder (straight) for flexible shafts

Length	Coupling	Weight	Item no.
42 x 193 mm	G 35 / MK 1-14	1,13 kg	K 0713
33 x 162 mm	G 28 / 12 mm	0,51 kg	K 0749
42 x 217 mm	G 35 / 12 mm	1,23 kg	K 0750



4

Overhung Spindles

Ø Outside x width x Ø inside	Coupling	Weight	Item no.
125 x 20 x 14 mm	MK 1-14	0,49 kg	K 0714
150 x 50 x 18 mm	MK 1-18	0,51 kg	K 0715
125 x 20 x 14 mm	12 mm	0,31 kg	K 0752
150 x 50 x 18 mm	12 mm	0,51 kg	K 0753

- for straight grinding machine: [K 0701-C](#)
- for toolholder
- with clamping plates for grinding wheels, brushes etc. for mounting tools on toolholders



Roughing Machine Grindings

Scope of delivery:

- Flexible shaft, DIN 10 / G 28: [K 0748](#)
- Toolholder
- Overhung spindles, MK 1-14: [K 0714](#)



Universal high power roughing machine with 3 Speeds from 3.000 - 12.000 rpm

Capacity	Weight	Item no.
1.700 W, 230 V, 50 Hz Coupling DIN 10	19,8 kg	K 0740-A
1.700 W, 110 V, 50 Hz Coupling DIN 15	15,5 kg	K 0740-B

Scope of delivery: tool holder for separation and buffing



Angle grinder for rubber and steel, discs Ø 125 mm

Capacity	Weight	Item no.
2.800 - 11.000 rpm, 1.200 W, 230 V, 50 Hz	2,2 kg	K 0790-A

Scope of delivery: tool holder for cutting disc



Angle grinder to work on metal discs Ø 230 mm

Capacity	Weight	Item no.
6.600 rpm, 2.200 W, 230 V, 50 Hz	5,8 kg	K 0791-A

Scope of delivery: rubber Plate, tool holder for buffing



Rotary sander for rubber processing, discs Ø 180 mm

Capacity	Weight	Item no.
1.500 - 4.000 rpm, 1.600 W, 230 V, 50 Hz	3,4 kg	K 0792-A

Scope of delivery: 5x Alloy steel roughing discs (optional in Grain 18: [K 0768](#), 23: [K 0769](#), or 36: [K 0770](#))



Star wheel grinder, safety hood with side plates and connection piece for buffing dust extraction 120 mm Buffing Width

Capacity	Weight	Item no.
1.200 - 3.700 rpm, 1.600 W, 230 V, 50 Hz	4 kg	K 0767-A



Straight grinder for rubber processing

Capacity	Weight	Item no.
1.400 - 3.000 rpm, 1.530 W, 230 V, 50/60 Hz, 14 -18 mm drilling	3,1 kg	K 0701-C
3.800 rpm, pneumatic, 17 mm drilling	5,2 kg	K 0666

Accessories

Alloy steel roughing discs

Grain	Inner diameter	Outer diameter	Item no.
18	22 mm	125 mm	K 0725
23			K 0726
18	22 mm	175 mm	K 0727
23			K 0728

- for angle grinder type [K 0790-A](#) and [K 0792-A](#) (on page 87)



Alloy steel roughing discs (star wheels)

Grain	Inner diameter	Outer diameter	Item no.
18	19 mm	100 mm	K 0768
23			K 0769
36			K 0770

- for star wheel grinder [K 0767-A](#) (on page 87)



Copperbound hardmetal roughing heads

Grain	Inner diameter	Outer diameter x Thickness	Item no.
18	14 mm	76 x 32 mm	K 0672
23			K 0719
18	14 mm	102 x 38 mm	K 0673
23			K 0720



Copperbound hardmetal roughing heads

Grain	Inner diameter	Outer diameter x Thickness	Item no.
18	14 mm	102 x 38 mm	K 0674
23			K 0721



Cut-off wheels

Inner diameter	Outer diameter x Thickness	Item no.
22 mm	125 x 2,5 mm	K 0805
	125 x 6,0 mm	K 0806
	230 x 3,0 mm	K 0734
	230 x 6,0 mm	K 0735
	230 x 8,0 mm	K 0736

- with clamping device for clamping flexible fiber discs



- with clamping device for use with resin fiber discs [K 0792-A](#) with [K 0729](#) or [K 0790-A](#) with [K 0808](#) (go to page 87)



- for angle grinder [K 0790-A](#) and [K 0791-A](#) (go to page 87)



Flexible support plates for angle grinder

Thread	Outer diameter	Item no.
M 14 for K 0792-A	180 mm	K 0729
M 14 for K 0790-A	125 mm	K 0808

Resin fiber discs

Grain	Inner diameter	Outer diameter	Item no.
16	22 mm	125 mm	K 0756
24			K 0801
40			K 0802
50			K 0803
60			K 0804
16			178 mm
24	K 0731		
40	K 0636		
50	K 0732		
60	K 0733		

Wire brushes

Inner diameter	Outer diameter x Thickness	Item no.
14 mm	100 x 30 mm	K 0747
16 mm	120 x 30 mm	K 0773
18 mm		K 0716
18 mm	150 x 30 mm	K 0742
20 mm	120 x 30 mm	K 0629

Concave brushes

Inner diameter	Outer diameter x Thickness	Item no.
14 mm	100 x 30 mm	K 0762
16 mm		K 0774
18 mm	100 x 25 mm	K 0717
20 mm	100 x 30 mm	K 0630

Tufted brushes

Inner diameter	Outer diameter x Thickness	Item no.
14 mm	100 x 50 mm	K 0761
16 mm	3-row	K 0775
18 mm	100 x 50 mm	K 0718
20 mm		5-row
30 mm	125 x 30 mm, 3-row	K 0755

Cable Cutter

Hydraulic cable cutter for wire cables up to Ø 12 mm

Capacity	Item no.
230 V, 50 Hz	K 0640
400 V, 50 Hz	K 0743
<hr/>	
Replacement blades (without connecting bolt)	K 0641



Cutting force for wire cables up to Ø 16 mm

Length	Weight	Item no.
630 mm	2,30 kg	K 0772
Replacement blades	-	K 0772-A



Cable cutting shear up to Ø 12 mm

Length	Weight	Item no.
700 mm	3,55 kg	K 0638
Replacement blades	-	K 0639









NILOS

Services

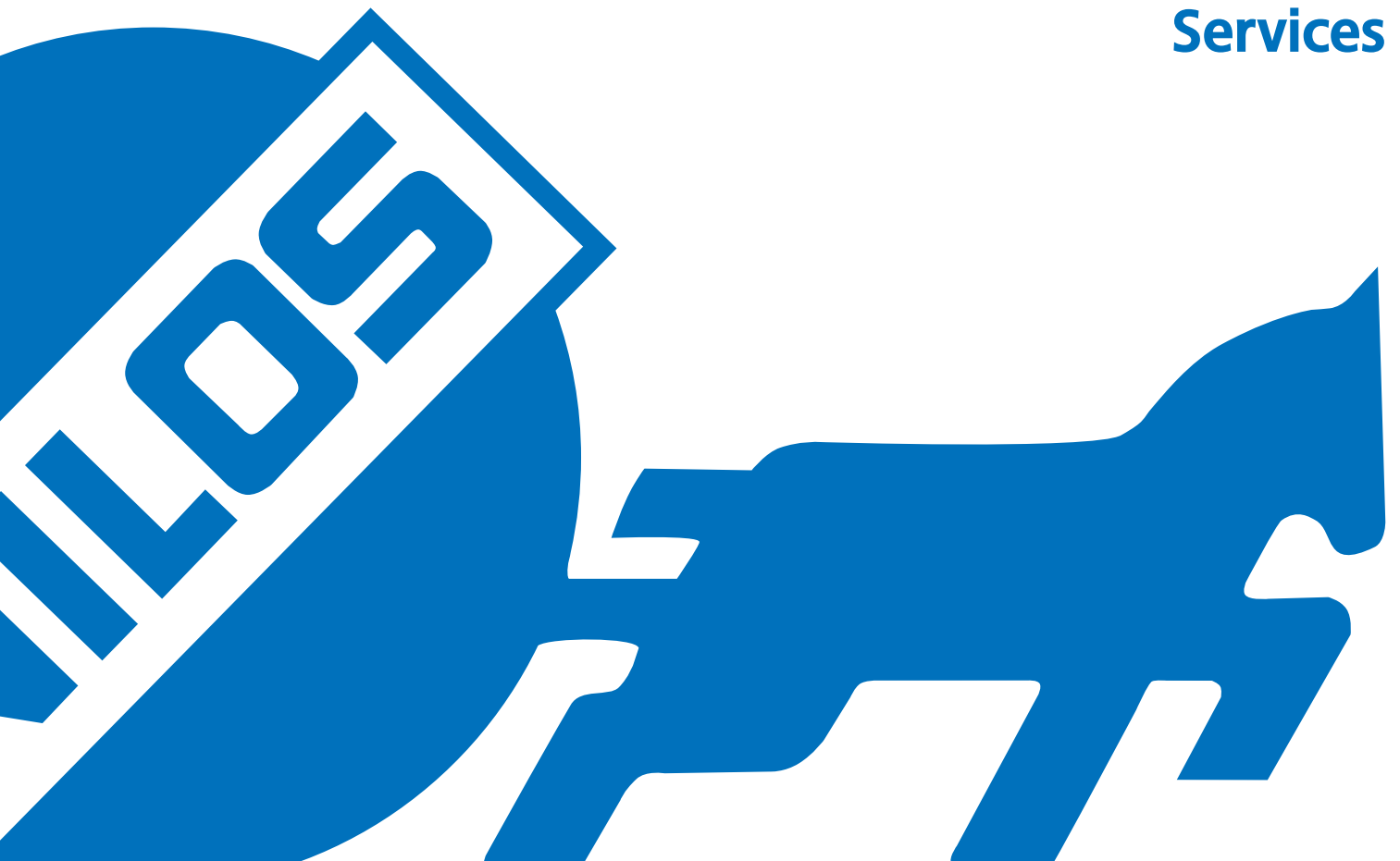

Services

NILOS offers almost all assembly services:

Belt repair and belt splices

- repairing of longitudinal cracks, transverse cracks, breakdowns and edge damage with hot vulcanizing
- repair of partial surface damage on running- and carrying sides with cold vulcanizing

Belt finishing

- by using hot vulcanizing the conveyor belt is subsequently provided with edge bead
- sidewalls and cleats of all kinds are applied with cold vulcanizing

Belt renewal

- the customer gets a good as new conveyor belt with the mileage of a new belt
- worn out belt surfaces are retreaded and vulcanized to original strength on running and carrying sides
- our know-how in Belt Recycling additionally enables the assembly of up to four individual strips to a belt body

Belt Recycling

- we offer the complete disposal of unusable conveyor belts to

Damage assessment and counseling

- damage assessment, definition of damage repair, NILOS testing laboratory for evaluation and validation of technical parameters

Training

A service that is often used and much appreciated is the training and instruction of belt vulcanizing operators at our factory. We transfer all the relevant theoretical and practical knowledge we have about conveyor belts.

NILOS campus

The knowledge gained during training courses can be implemented into daily working processes. Preventive maintenance and detection of faults as well as purposeful adjustment will be facilitated. Expert instructions and skilled trainers with many years of experience and highest qualifications conduct the theoretical and practical schooling and training course: campus@nilos.de

Operating Belt Conveyors

We do the worrying when it comes to your conveying problems and regular scheduled maintenance for your conveyor belt unit. Our technicians will put right any problems and faults in the shortest possible time.

Final Disposal

Old belts that can no longer be recycled are disposed of in a cost-effective and environmentally friendly way.

Franchising

There is an additional option, to make use of the know-how, infrastructure and products of the NILOS brand as a NILOS franchising partner and thus ensuring a presence in the market as a strong and competent partner.

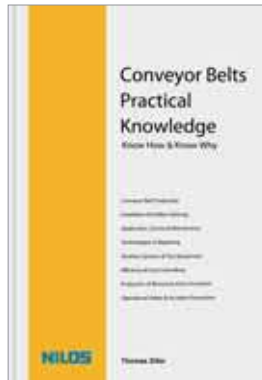

NILOS

CAMPUS



Scan the QR-Code and learn more about NILOS on www.nilos.de.

Conveyor belts require a high amount of investment in belt units. Conveyor belt repair, regeneration and refurbishing preserve the resources of our planet. NILOS offers workshop facilities with tried and tested technology for the refurbishing of damaged or worn fabric and steel cord belts. Decades of experience in practice guarantee our competence in planning, design and equipping.

Starting with the servicing of small- and medium-sized damaged areas, the repair facilities also include conveyor belt regeneration and refurbishing, supplemented by the use of unvulcanized rubber materials from our own preparation division.

We can offer the following type of workshop facilities:

NILOS Repair Workshop

Splicing, repairing of damaged belts and service facilities in plant and on site with mobile vulcanizers.

NILOS Regeneration Workshop

Treating worn areas on conveyor belts that are still usable overall.

NILOS Reconditioning Workshop

Incorporation of new belt partial strips and overall refurbishing of damaged or worn conveyor belts.

NILOS Workshop for Conveyor belt Regeneration with Rubber Preparation Division and Test Laboratory

The combination of the above-mentioned types makes it possible to carry out the work completely independently and without any additional suppliers, thanks to special machine facilities.

These four basic types can be adapted individually to customer-specific requirements. Any existing suitable facilities are incorporated in the planning and setting up.



Design and Supply of Complete Conveyor belt Repair Workshops
Realization with a wide range of equipment and special-purpose machines developed by us, on request.

Specialized personnel can be trained by us – the program includes complete instruction of NILOS technology and know-how transfer for the repair of conveyor belts of all types and sizes.

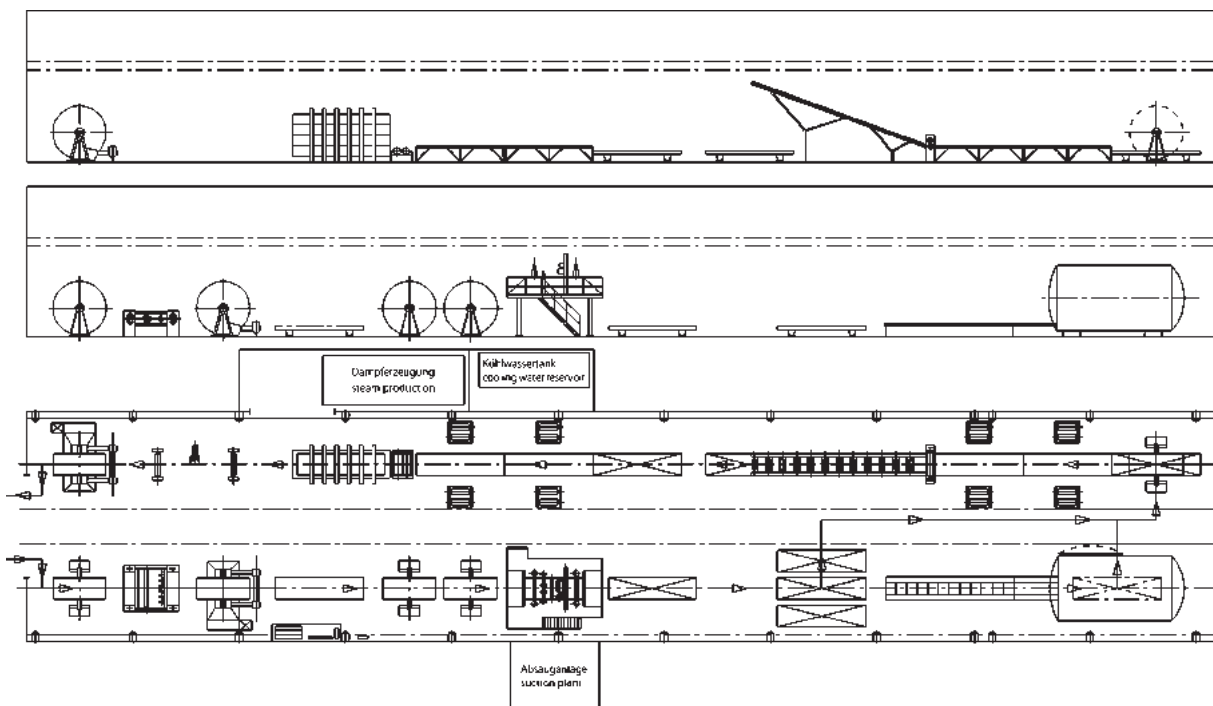

Technical questionnaire for vulcanizing presses



Relevant dimensions to define the size of a heating platen

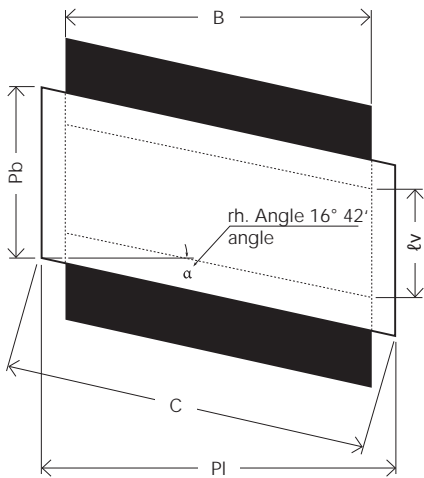

Pb = plate width
Pl = plate length
C = edge length
B = belt width
l v = splice length

NILOS GmbH & Co. KG
Reisholzstr. 15
40721 Hilden • Germany
Phone: +49 2103 951-0
Fax: +49 2103 951-209
info@nilos.de
www.nilos.de



Please fill out this questionnaire as completely as possible:

1. Contact Information

Mr Mrs

Contact person

Phone

E-mail

Company

Street & no.

Zip Code & City

Country

Country of use

2. Belt type

- Steel cord belt
 Textile conveyor belt

3. Place of operation

- Underground
 Above ground

4. Type of splice

- rhombic 16° 42'
 rhombic 22°
 rectangular 90°

5. Power supply

- 220/230 V 3-Ph + Pe
 400 V 3-Ph + Pe + N
 480 V 3-Ph + Pe
 _____ V

6. Belt width

- 500 650 800 1000 1200 1400 1600 1800 2000 _____
 24" 26" 36" 40" 48" 54" 60" 72" 78" _____

- 60 Hz / 60 C/S
 50 Hz / 50 C/S

7. Your splice length in mm according to belt manufacturer

- 500 650 800 1000 1200 1400 1600 1800 2000 _____

8. Temperature

_____ F

9. Belt quality (EP500/4 / ST2000...)

10. Specific surface pressure



NILOS

Technical questionnaire for vulcanizing presses

- Please note the relevant dimensions to define the size of a heating platen
- Please fill out this questionnaire as completely as possible





Scan QR-Code and load
the complete Catalogue.



NILOS

The technical information is based on latest state of technology.
We reserve the right to make structural and design changes in the
interest of progress. We ask for your understanding that no liability
can be assumed for printing errors or mistakes. Reproduction or
reprinting, in whole or in part, is not permitted without our express
permission.

NGK-0120_EN
This renders all previous instructions invalid.

NILOS GmbH & Co. KG
Reisholzstr. 15
40721 Hilden · Germany
Phone: +49 2103 951-0
Fax: +49 2103 951-209
info@nilos.de
www.nilos.de