

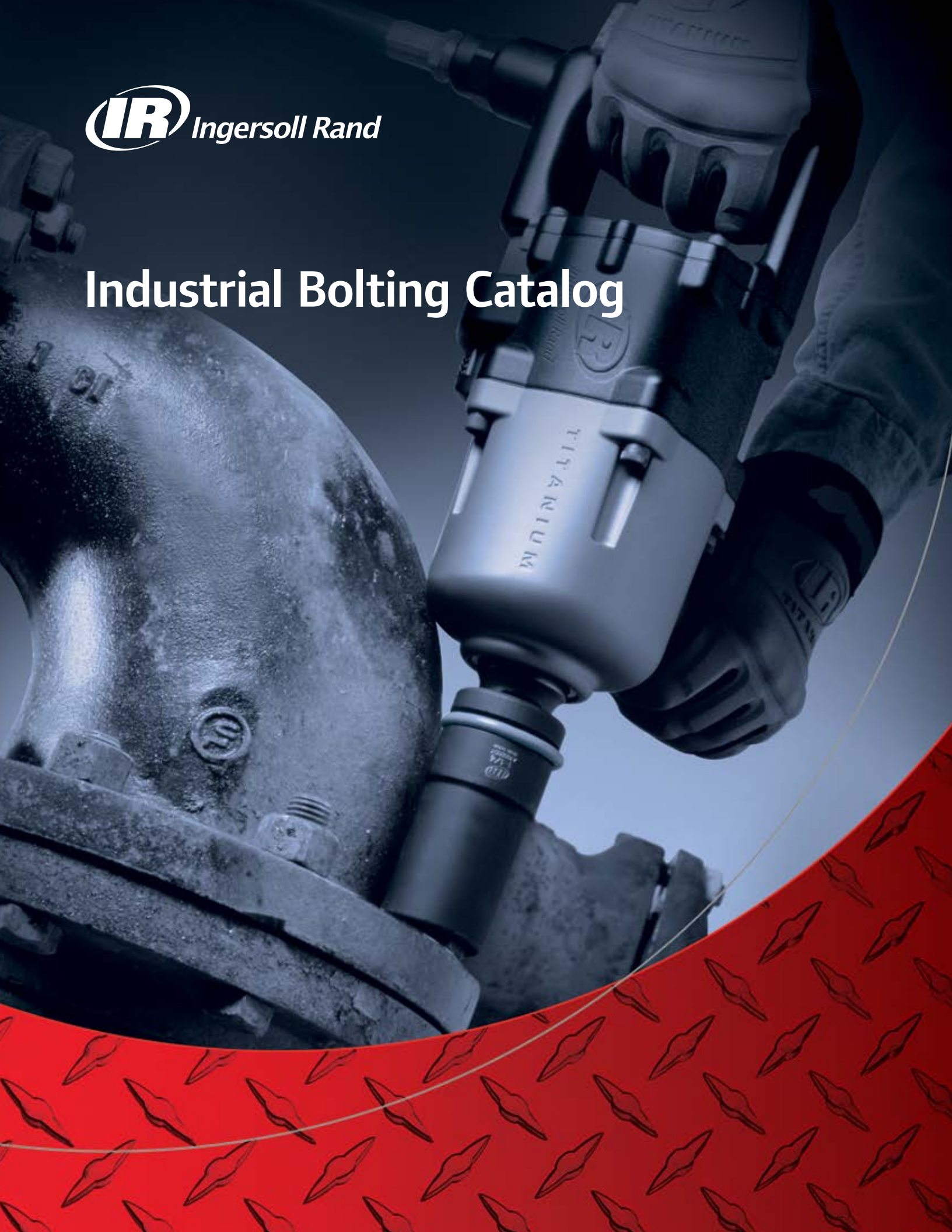

Industrial Bolting Catalog



The name says it all



Productivity has come a long way since Ingersoll Rand introduced the first Impactool™ in 1934. What has not changed is our reputation for world-class tools that set the industry standard for power, durability, and reliability. Every Impactool bearing the Ingersoll Rand name reflects our commitment to delivering cutting-edge tool designs that work as hard as you do and provide maximum comfort, safety, efficiency, and serviceability. Throughout this catalog, you will find Ingersoll Rand Impactools offering several different impact technologies to best suit your wide range of applications.



Performance Classifications

Super-duty tools are designed to tackle the most extreme jobs. Advanced technology gives these tools superior strength and durability across the widest range of applications.

Heavy-duty tools are top-quality models that exceed the requirements of highly demanding applications and environments. They are engineered with special features for top power, speed control, accuracy, and comfort.

Maintenance-duty tools are durable, high-quality, impressively powerful, and have added features for frequent or rigorous applications.

Air Impact Mechanisms

Twin Hammer design delivers more power per pound and is less sensitive to air pressure fluctuations than any other type of impact mechanism. This Ingersoll Rand technology has become the industry standard and is suitable for hard or soft-draw applications.

Jumbo Hammer performs similarly to the Twin Hammer, but employs a single hammer.

Ball and Cam mechanisms are ideal for soft-draw applications, and are commonly used in larger Impacttools.



Twin Hammer

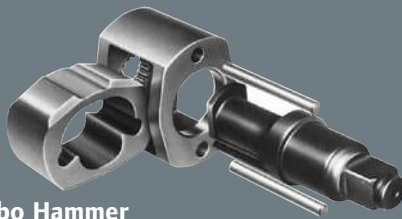

Jumbo Hammer

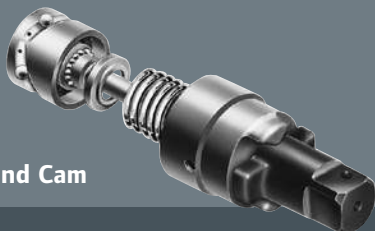

Ball and Cam



Contents

Air Impactools™

Ingersoll Rand has the right air Impactool for virtually any job — covering anything from light production to heavy duty maintenance and repair.

Product Overview	6 – 9
3/8" – 1/2" Drive	10 – 12
2100 MAX Series	10
1702 Series, 2700 Series	11
2900 Series, Tune-up / Hammer and Anvil Kits	12
3/4" – 1" Drive	13 – 16
2100 Series, 1700 Series	13
2920 Series, 2925Ti Series	14
2934 Series, 3940Ti Series	15
3942Ti Series, Tune-up / Hammer and Anvil Kits	16
1-1/2" – 3-1/2" Drive	17
3955Ti Series, 5000 Series	17

Cordless Impactools

Power. Durability. Reliability. With Ingersoll Rand cordless tools you get the perfect combination of world-class engineering and durability, unsurpassed battery capabilities, and the portability that you'd expect from cordless.

Product Overview	18
Cordless Impactools	19

Accessories

Our selection of impact sockets and job-specific accessories reflect the same high standard of performance you expect from Ingersoll Rand.

Product Overview	20
Sockets and Accessories	21 – 31
Couplers and Plugs	32
Hoses and Fittings	33
Filters, Regulators, and Lubricators	34
Spring Balancers	35

Technical Symbols

For ease of use, specification tables frequently use symbols in column headings. Please reference the chart below for exact descriptions.

Impacttools



Free speed

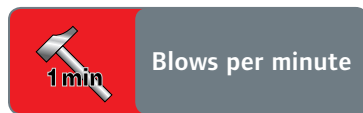

Blows per minute



Max. torque



Torque range



Tool weight



Tool length



Side-to-center distance



Minimum hose size



Max. air consumption



Voltage



Sound level



Vibration level

Accessories



NPT size



Hose inner diameter



Hose length



Hose outer diameter



Max. working pressure



Lift



Capacity

Air Impacttools



**The hardest hitting
Impacttools in the business.**

We offer a wide range of pneumatic Impacttools that deliver the flexibility you need to fit even the most unique and demanding applications. Whether it's light routine repair work, or heavy-duty maintenance, Ingersoll Rand has the right tool for the job.

Our Impacttools are designed with durability in mind, from the vanes turning the motor to the hammer frames and anvils. Proprietary hardening and treatment processes, innovative ergonomic designs, and excellence in manufacturing all add up to the longest lasting, hardest hitting Impacttools in the business.

Torque Ranges

Ingersoll Rand Impacttools range in torque from 45 to 5,288 ft-lb. See the chart below to find the series that fits your torque requirements.

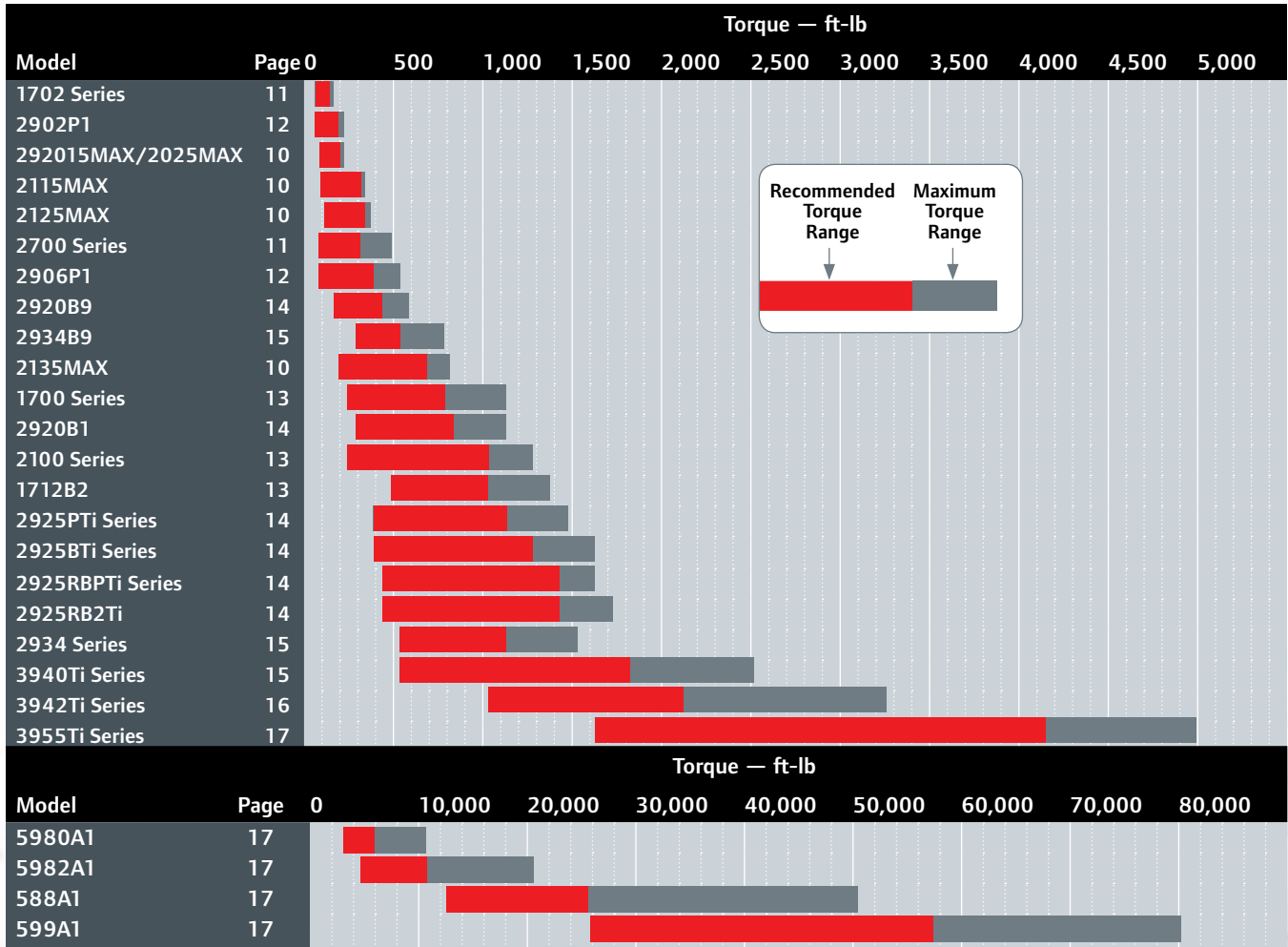

Air Impactool Selection Guide

This chart will assist you in selecting a particular Impactool for a specific application. The figures used are based on 70 percent of the tension proof load of a given size and bolt grade.

For example, a Grade 5 bolt has a proof load of 94,200 psi. A 1/2" Grade 5 bolt has a tensile stress area — the cross-section at the root of the thread — of 0.1282 sq in, and an actual proof load of 12,076 lb. Seventy percent of this proof load is 8,453 lb. By looking at the chart, we find that in order to put 8,450 lb of tension on the 1/2" UNC Grade 5 bolt, we must apply 70 ft-lb of torque. To do this, we recommend the 2906 Series Impactool. Remember that 70 percent of the proof load is normally the amount of tension needed to ensure a properly tightened joint.

Bolt Grade	Bolt Diam – in (mm)	1/4"	5/16"	3/8"	7/16"	1/2"	9/16"	5/8"	3/4"	7/8"	1"	1-1/8"	1-1/4"	
		(6)	(8)	(10)	(11)	(13)	(14)	(16)	(19)	(22)	(25)	(29)	(32)	
	Hex Size – in Max Min	1/2"	19/32"	11/16"	25/32"	7/8"	31/32"	1-1/16"	1-1/4"	1-7/16"	1-5/8"	1-13/16"	2"	
		3/8"	15/32"	9/16"	21/32"	3/4"	27/32"	15/16"	1-1/8"	1-5/16"	1-1/2"	1-11/16"	1-7/8"	
Grade 1	Torque	ft-lb (Nm)	3 (4.07)	6 (8.14)	11 (14.9)	18 (24.4)	28 (38)	43 (58.3)	55 (74.6)	97 (132)	155 (210)	230 (312)	340 (461)	480 (651)
	Impactool Recommended		2902	2902	2902	2906	2906	2906	2906	1720	1720	2925	2925	2934
	Tension	lb (kN)	730 (3.24)	1,210 (5.38)	1,800 (8.01)	2,460 (10.9)	3,280 (14.6)	4,200 (18.7)	5,200 (23.1)	7,000 (31.1)	10,600 (47.1)	14,000 (62.3)	18,200 (80.9)	23,000 (102)
Grade 5	Torque	ft-lb (Nm)	8 (10.8)	16 (21.7)	28 (38)	46 (62.4)	70 (95)	110 (149)	140 (190)	250 (339)	405 (549)	600 (814)	770 (1044)	1,080 (1464)
	Impactool Recommended		2902	2902	2902	2906	2906	2906	1720	2925	2925	2934	2934	3940
	Tension	lb (kN)	1,900 (8.4)	3,100 (13.8)	4,600 (20.4)	6,350 (28.2)	8,450 (37.6)	10,900 (48.5)	13,500 (60)	20,000 (89)	27,400 (122)	36,000 (160)	41,000 (182)	52,000 (231)
ASTM-A325	Torque	ft-lb (Nm)	–	–	–	–	–	–	200 (271)	355 (481)	570 (773)	850 (1153)	1,060 (1437)	1,495 (2027)
	Impactool Recommended		–	–	–	–	–	–	2925	2934	2934	2934	3940	3942
	Tension	lb (kN)	–	–	–	–	–	–	19,000 (44.5)	28,000 (124)	39,000 (173)	51,000 (227)	56,000 (249)	71,000 (319)
Grade BB ASTM-A354	Torque	ft-lb (Nm)	8 (10.8)	15 (20.3)	27 (36.6)	43 (58.3)	66 (89.5)	106 (144)	131 (178)	234 (317)	376 (510)	565 (766)	830 (1125)	1,170 (1586)
	Impactool Recommended		2902	2902	2902	2906	2906	2906	1720	2925	2929	2934	2934	3940
	Tension	lb (kN)	1,780 (7.9)	2,930 (13)	4,340 (19.3)	5,950 (26.5)	7,950 (35.4)	10,190 (45.3)	12,660 (56.3)	18,700 (83.1)	25,870 (115)	33,940 (151)	44,240 (196)	56,000 (249)
Grade BC ASTM-A354	Torque	ft-lb (Nm)	10 (13.6)	20 (27.1)	35 (47.5)	56 (75.9)	86 (117)	138 (187)	173 (234)	306 (415)	495 (671)	742 (1006)	1,090 (1478)	1,530 (2075)
	Impactool Recommended		2902	2902	2906	2906	2906	2906	1720	2925	2934	2934	3940	3942
	Tension	lb (kN)	2,340 (10.4)	3,850 (17.1)	5,700 (25.3)	7,815 (34.8)	10,430 (46.4)	13,380 (59.5)	16,610 (74)	24,550 (109)	33,960 (151)	44,550 (198)	58,070 (258)	73,500 (327)
Grade 8 ASTM-A354 Grade BD	Torque	ft-lb (Nm)	11 (14.9)	23 (31.2)	40 (54.2)	65 (88.1)	99 (134)	159 (216)	198 (268)	350 (475)	566 (767)	848 (1150)	1,245 (1688)	1,750 (2373)
	Impactool Recommended		2902	2902	2906	2906	2906	2906	1720	2925	2934	2934	3940	3955
	Tension	lb (kN)	2,740 (12.2)	4,400 (19.6)	6,510 (28.9)	8,930 (39.7)	11,920 (53)	15,290 (68)	18,980 (84.4)	28,050 (125)	38,800 (172)	50,900 (226)	66,360 (295)	84,000 (374)
ASTM-A490	Torque	ft-lb (Nm)	–	–	–	–	–	–	250 (339)	435 (590)	715 (970)	1,070 (1451)	1,580 (2142)	2,125 (2882)
	Impactool Recommended		–	–	–	–	–	–	2925	2934	2934	3940	3942	3955
	Tension	lb (kN)	–	–	–	–	–	–	24,000 (107)	35,000 (156)	49,000 (218)	64,000 (285)	80,000 (356)	102,000 (454)

The appropriate torque required to achieve 70 ft-lb is based on the formula $T = kDL$, where T = torque (ft-lb), k = frictional constant = 0.2*, D = fastener diameter (ft), and L = loader tension (lb).

*The frictional constant can vary based on thread condition, lubrication, and surface conditions, and should be established through testing for critical applications.

Only certain tools are shown in this chart. Compare the required torque shown with torque ranges shown in the tool specifications tables to select other suitable tools.

Bolt Grade	Bolt Diam – in (mm)	1-3/8"	1-1/2"	1-5/8"	1-3/4"	2"	2-1/4"	2-1/2"	2-3/4"	3"	3-1/4"	3-1/2"	3-3/4"	4"
		(35)	(38)	(41)	(44)	(51)	(57)	(64)	(70)	(76)	(83)	(89)	(95)	(102)
Hex Size – in Max Min		2-3/16" 2-1/8"	2-3/8" 2-1/4"	2-9/16" 2-7/16"	2-3/4" 2-5/8"	3-1/8" 3"	3-3/8" 3-1/2"	3-7/8" 3-3/4"	4-1/4" 4-1/8"	4-5/8" 4-1/2"	5" 4-7/8"	5-3/8" 5-1/4"	5-3/4" 5-5/8"	6-1/8" 6"
Grade 1	Torque ft-lb (Nm)	660 (895)	860 (1166)	-	-	-	-	-	-	-	-	-	-	-
	Impactool Recommended	2934	3940	-	-	-	-	-	-	-	-	-	-	-
	Tension lb (kN)	28,400 (126)	34,600 (154)	-	-	-	-	-	-	-	-	-	-	-
Grade 5	Torque ft-lb (Nm)	1,470 (1933)	1,950 (2644)	-	-	-	-	-	-	-	-	-	-	-
	Impactool Recommended	3942	3955	-	-	-	-	-	-	-	-	-	-	-
	Tension lb (kN)	64,000 (285)	77,000 (342)	-	-	-	-	-	-	-	-	-	-	-
ASTM-A325	Torque ft-lb (Nm)	1,960 (2658)	1,950 (3526)	-	-	-	-	-	-	-	-	-	-	-
	Impactool Recommended	3955	5980	<i>These bolts are used on structural steel applications. Torque and tension values are based on running the nut beyond the proof load of the bolt by the turn of the nut method. For detailed information consult the bolt manufacturer.</i>										
	Tension lb (kN)	85,000 (378)	103,000 (458)	-	-	-	-	-	-	-	-	-	-	-
Grade BB ASTM-A354	Torque ft-lb (Nm)	1,580 (2142)	2,080 (2820)	2,700 (3661)	3,400 (4610)	5,150 (6983)	7,500 (10170)	10,300 (13967)	13,100 (17764)	17,100 (23188)	21,800 (29561)	27,500 (37290)	34,000 (46104)	41,300 (56003)
	Impactool Recommended	3942	3955	5980	5980	155,120	5982	588	588	588	599	599	599	599
	Tension lb (kN)	69,050 (307)	83,550 (371)	99,680 (443)	116,480 (518)	155,120 (690)	199,360 (887)	248,640 (1106)	285,080 (1268)	314,780 (1520)	403,725 (1796)	470,400 (2092)	542,850 (2414)	620,025 (2758)
Grade BC ASTM-A354	Torque ft-lb (Nm)	2,075 (2814)	2,440 (3309)	3,545 (4807)	4,465 (6054)	6,785 (9200)	9,815 (13309)	13,600 (18442)	16,550 (22442)	21,645 (29351)	27,000 (37561)	34,760 (47134)	42,980 (58281)	52,360 (71000)
	Impactool Recommended	3955	5980	5980	5980	5982	5982	588	588	588	599	599	599	599
	Tension lb (kN)	90,360 (403)	109,620 (488)	130,830 (582)	152,880 (680)	203,950 (907)	261,660 (1164)	326,340 (1452)	361,100 (1606)	432,910 (1926)	517,690 (2303)	595,840 (2650)	687,610 (3058)	787,370 (3493)
Grade 8 ASTM-A354 Grade BD	Torque ft-lb (Nm)	2,375 (3220)	3,135 (4251)	-	-	-	-	-	-	-	-	-	-	-
	Impactool Recommended	3955	5980	-	-	-	-	-	-	-	-	-	-	-
	Tension lb (kN)	103,570 (461)	125,330 (557)	-	-	-	-	-	-	-	-	-	-	-
ASTM-A490	Torque ft-lb (Nm)	2,780 (3770)	3,700 (5017)	-	-	-	-	-	-	-	-	-	-	-
	Impactool Recommended	5980	5980	<i>These bolts are used on structural steel applications. Torque and tension values are based on running the nut beyond the proof load of the bolt by the turn of the nut method. For detailed information consult the bolt manufacturer.</i>										
	Tension lb (kN)	121,000 (538)	148,000 (658)	-	-	-	-	-	-	-	-	-	-	-











2100 MAX Series



MAINTENANCE DUTY

- Titanium hammer case
- Cast aluminum hammer case (2015/25 MAX)
- Composite housing
- Reverse-biased motor
- Twin hammer mechanism
- Single hammer mechanism (2015/25 MAX)
- 1/4" NPT inlet

Model	Description	Details	Handle									
				rpm	ft-lb (Nm)	ft-lb (Nm)	lb (kg)	in (mm)	in (mm)	in (mm)	cfm	
2015MAX	3/8" Square at 90°	Hog-ring	Straight	7,100	2,100	F: 150 (203) R: 180 (244)	F: 45 – 140 (61 – 190) R: 45 – 160 (61 – 217)	3.4 (1.54)	13.1 (332)	1.1 (28)	3/8 (10)	19 (538)
2025MAX	1/2" Square at 90°	Hog-ring	Straight	7,100	2,100	F: 150 (203) R: 180 (244)	F: 45 – 140 (61 – 190) R: 45 – 160 (61 – 217)	3.4 (1.54)	13.1 (332)	1.1 (28)	3/8 (10)	19 (538)
2115TiMAX	3/8" Square	Hog-ring	Pistol	15,000	1,500	F: 250 (339) R: 300 (407)	F: 25 – 230 (34 – 312) R: 55 – 280 (75 – 300)	2.48 (1.12)	5.95 (151)	1.1 (28)	3/8 (10)	17 (481)
2115QTiMAX	3/8" Square	Hog-ring, Quietool	Pistol	15,000	1,500	F: 250 (339) R: 300 (407)	F: 25 – 230 (34 – 312) R: 55 – 280 (75 – 300)	2.48 (1.12)	5.95 (151)	1.1 (28)	3/8 (10)	17 (481)
2115PTiMAX	3/8" Square	Pin Retainer, Quietool	Pistol	15,000	1,500	F: 250 (339) R: 300 (407)	F: 25 – 230 (34 – 312) R: 55 – 280 (75 – 300)	2.48 (1.12)	5.95 (151)	1.1 (28)	3/8 (10)	17 (481)
2125QTiMAX	1/2" Square	Hog-ring, Quietool	Pistol	15,000	1,500	F: 277 (375) R: 332 (450)	F: 25 – 251 (34 – 340) R: 76 – 302 (103 – 410)	2.51 (1.14)	6.1 (155)	1.1 (28)	3/8 (10)	17 (481)
2125PTiMAX	1/2" Square	Pin Retainer, Quietool	Pistol	15,000	1,500	F: 277 (375) R: 332 (450)	F: 25 – 251 (34 – 340) R: 76 – 302 (103 – 410)	2.51 (1.14)	6.1 (155)	1.1 (28)	3/8 (10)	17 (481)
2135TiMAX	1/2" Square	Hog-ring	Pistol	9,800	1,250	F: 600 (813) R: 780 (1054)	F: 50 – 550 (68 – 746) R: 150 – 650 (203 – 880)	3.95 (1.79)	7.35 (186.7)	1- 3/8 (35)	3/8 (10)	24 (680)
2135QTiMAX	1/2" Square	Hog-ring, Quietool	Pistol	9,800	1,250	F: 600 (813) R: 780 (1054)	F: 50 – 550 (68 – 746) R: 150 – 650 (203 – 880)	3.95 (1.79)	7.35 (186.7)	1- 3/8 (35)	3/8 (10)	24 (680)
2135PTiMAX	1/2" Square	Pin Retainer	Pistol	9,800	1,250	F: 600 (813) R: 780 (1054)	F: 50 – 550 (68 – 746) R: 150 – 650 (203 – 880)	3.95 (1.79)	7.35 (186.7)	1- 3/8 (35)	3/8 (10)	24 (680)
2135QPTiMAX	1/2" Square	Pin Retainer, Quietool	Pistol	9,800	1,250	F: 600 (813) R: 780 (1054)	F: 50 – 550 (68 – 746) R: 150 – 650 (203 – 880)	3.95 (1.79)	7.35 (186.7)	1- 3/8 (35)	3/8 (10)	24 (680)



1702 Series



1702P1



1702SB1

HEAVY DUTY

- Jumbo hammer mechanism
- Steel hammer case
- Pressure-fed mechanism lubrication
- 1/4" NPT inlet

Model	Description	Details	Handle									
				rpm	ft-lb (Nm)	ft-lb (Nm)	lb (kg)	in (mm)	in (mm)	in (mm)	cfm	
1702P1	3/8" square	Pin Retainer	Pistol	10,000	1,500	125 (170)	20 - 100 (27 - 136)	2.75 (1.25)	5.5 (140)	1.38 (34)	5/16 (8)	15 (425)
1702P4	1/4" hex	Pin Retainer	Pistol	10,000	1,500	125 (170)	20 - 100 (27 - 136)	2.75 (1.25)	5.5 (140)	1.38 (35)	5/16 (8)	15 (425)
1702SB1	3/8" square	Pin Retainer	Straight	10,000	1,500	105 (142)	13 - 85 (18 - 115)	2.5 (1.12)	5.88 (149)	1 (25)	5/16 (8)	13 (368)

2700 Series



2705P1



2707P1

HEAVY DUTY

- Jumbo hammer mechanism
- Steel hammer case
- Pressure-fed mechanism lubrication
- 1/4" NPT inlet

Model	Description	Details	Handle									
				rpm	ft-lb (Nm)	ft-lb (Nm)	lb (kg)	in (mm)	in (mm)	in (mm)	cfm	
2705P1	1/2" square	Pin Retainer	Pistol	8,500	1,200	400 (542)	40 - 250 (54 - 271)	5.63 (2.55)	6.75 (171)	1.38 (34)	3/8 (10)	23 (651)
2707P1	1/2" hex	Pin Retainer	Pistol	7,750	1,300	450 (610)	40 - 275 (54 - 373)	6 (2.72)	6.5 (165)	1.38 (34)	3/8 (10)	26 (736)



2900 Series











2902P1



2906P1

SUPER DUTY

- Steel hammer case
- Jumbo hammer mechanism (2902P1)
- Twin hammer mechanism (2906P1)
- Pressure-fed mechanism lubrication
- Integral muffler
- 1/4" NPT inlet

Model	Description	Details	Handle	 1 min.	 1 min	 Max ft-lbs	 ft-lbs	 lb (kg)	 in (mm)	 in (mm)	 in (mm)	 cfm
				rpm		ft-lb (Nm)	ft-lb (Nm)	lb (kg)	in (mm)	in (mm)	in (mm)	cfm
2902P1	3/8" square	Pin Retainer	Pistol	10,000	1,500	180 (244)	20 – 150 (27 – 204)	2.5 (1.25)	5.5 (140)	1.38 (35)	3/8 (10)	15 (425)
2906P1	1/2" square	Pin Retainer	Pistol	5,000	1,200	500 (678)	40 – 350 (54 – 475)	6 (2.72)	6.88 (175)	1.34 (34)	3/8 (10)	23 (651)

Tune-up kits

Part Number	For Use With
3/8" & 1/2" IMPACTOOL	
2015-TK	2015/25 MAX
2115-TK2	2115/25 MAX
2135-TK2	2135 MAX
1702SB-TK2	1702SB1
1702P-TK2	1702P1, 2902P1
2705-TK3	2705P1
2707-TK2	2707P1
2906P-TK1	2906P1

Hammer kits

Part Number	For Use With
3/8" & 1/2" IMPACTOOL	
2015-THK	2015/25 MAX
2115-THK2	2115/25 MAX
2135-THK1	2135TiMAX 2135QTiMAX
2135PTi-THK1	2135PTiMAX 2135QPTiMAX

Note: Ingersoll Rand lubricants and greases are available to fulfill maintenance needs.

Anvils & hangers

Part Number	Description	For Use With
3/8" & 1/2" IMPACTOOL		
1702-A926-4	1/4" hex quick change anvil assembly	1702/2902 Series
2U-A925-4	Quick change chuck for 1/4" hex shank accessories	1702/2902 Series
1702-A926-7	7/16" hex quick change anvil assembly	1702/2902 Series
502-A925-7	Quick change chuck for 7/16" hex shank accessories	1702/2902 Series
705-A926-7	7/16" hex quick change anvil assembly	2906P1
1901-365	Vertical hanger	1702SB1
2908-365	Vertical hanger	2906P1
1901-366	Horizontal hanger	1702SB1
2706-366	Horizontal hanger	2707P1
904-366	Horizontal hanger	2906P1
2U-215	Socket adapter (3/8" to 1/2")	1702SB1





2100 Series



2141P

2171XP

MAINTENANCE DUTY

- Steel hammer case
- Composite housing (2141, 2141P)
- Twin hammer mechanism
- Jumbo hammer mechanism (2161, 2171P)
- 3/8 NPT inlet

Model	Description	Details	Handle	rpm	ft-lb (Nm)	ft-lb (Nm)	ft-lb (Nm)	lb (kg)	in (mm)	in (mm)	in (mm)	cfm
2141	3/4" square Reverse bias motor	Hog-ring	Pistol	7,250	1,175	F: 1,100 (1492) R: 1,200 (1627)	F: 200 - 900 (272 - 1220) R: 200 - 900 (272 - 1220)	7.15 (3.24)	8.3 (210)	1.84 (47)	1/2 (13)	40 (1133)
2141P	3/4" square Reverse bias motor	Through-hole socket retainer	Pistol	7,250	1,175	F: 1,100 (1492) R: 1,200 (1627)	F: 200 - 900 (272 - 1220) R: 200 - 900 (272 - 1220)	7.15 (3.24)	8.3 (210)	1.84 (47)	1/2 (13)	40 (1133)
2161XP	3/4" square	Hog-ring	Pistol	6,000	1,025	1,250 (1695)	300 - 1,000 (407 - 1360)	12.14 (5.5)	8.3 (210)	1.75 (44)	1/2 (13)	46 (1303)
2161P	3/4" square	Through-hole socket retainer	Pistol	6,000	1,025	1,250 (1695)	300 - 1,000 (407 - 1360)	12.14 (5.5)	8.3 (210)	1.75 (44)	1/2 (13)	46 (1303)
2171XP	1" square	Hog-ring	Pistol	6,000	1,025	1,250 (1695)	300 - 1,000 (407 - 1360)	12.32 (5.6)	8.5 (216)	1.75 (44)	1/2 (13)	46 (1303)
2171P	1" square	Through-hole socket retainer	Pistol	6,000	1,025	1,250 (1695)	300 - 1,000 (407 - 1360)	12.32 (5.6)	8.5 (216)	1.75 (44)	1/2 (13)	46 (1303)

1700 Series



1720P1

1720B1

HEAVY DUTY

- Steel hammer case
- Jumbo hammer mechanism
- Pressure-feed mechanism lubrication
- Integral muffler
- 3/8" inlet

Model	Description	Details	Handle	rpm	ft-lb (Nm)	ft-lb (Nm)	ft-lb (Nm)	lb (kg)	in (mm)	in (mm)	in (mm)	cfm
1720P1	3/4" square	Through-hole socket retainer	Pistol	5,500	1,000 (1360)	1,100 (1491)	200 - 600 (271 - 814)	12.54 (5.65)	7.63 (194)	1.91 (48)	1/2 (13)	40 (1133)
1720P3	1" square	Through-hole socket retainer	Pistol	5,500	1,100 (1491)	1,100 (1491)	250 - 750 (339 - 1017)	12.54 (5.65)	7.63 (194)	1.91 (48)	1/2 (13)	40 (1133)
1720B1	3/4" square	Through-hole socket retainer	Grip I.T.	5,500	1,000 (1360)	1,100 (1491)	200 - 600 (271 - 814)	13.87 (6.29)	11.75 (299)	1.91 (48)	1/2 (13)	40 (1133)
1720B3	1" square	Through-hole socket retainer	Grip I.T.	5,500	1,100 (1491)	1,100 (1491)	250 - 750 (339 - 1017)	13.87 (6.29)	11.75 (299)	1.91 (48)	1/2 (13)	40 (1133)
1712B2	1" square	Through-hole socket retainer	Grip I.T.	6,000	800	1,350 (1898)	450 - 1,000 (610 - 1356)	18.25 (8.28)	11.25 (286)	2.19 (56)	3/4 (19)	47 (1331)



2920 Series



SUPER DUTY

- Steel hammer case
- Twin hammer mechanism
- Pressure-fed mechanism lubrication
- Integral muffler
- 3/8" NPT inlet

Model	Description	Details	Handle									
				rpm	rpm	ft-lb (Nm)	ft-lb (Nm)	lb (kg)	in (mm)	in (mm)	in (mm)	cfm
2920B1	3/4" square	Through-hole socket retainer	Grip	5,000	950	1,100 (1492)	250 – 800 (339 – 1085)	13.19 (5.98)	12.5 (318)	1.91 (49)	1/2 (13)	36 (1020)
2920B9	3/4" square at 90°	Through-hole socket retainer	Grip	5,000	950	550 (746)	125 – 400 (170 – 542)	23.69 (10.75)	17.5 (445)	1.31 (33)	1/2 (13)	36 (1020)

2925Ti Series



SUPER DUTY

- Titanium hammer case
- Corrode-X™ component package
- Twin hammer mechanism
- Choice of balanced or reversed bias motor
- Pressure-fed mechanism lubrication
- Integral muffler
- 3/8" NPT inlet

Model	Description	Details	Handle									
				rpm	rpm	ft-lb (Nm)	ft-lb (Nm)	lb (kg)	in (mm)	in (mm)	in (mm)	cfm
2925P1Ti	3/4" square	Through-hole socket retainer	Pistol	5,200	1,050	1,450 (1966)	350 – 1,100 (475 – 1492)	12 (5.44)	8.9 (225)	1.75 (44)	1/2 (13)	60 (1699)
2925RBP1Ti	3/4" square reverse bias	Through-hole socket retainer	Pistol	5,200	1,050	F: 1,300 (1763) R: 1,600 (2169)	F: 300 – 950 (407 – 1288) R: 400 – 1,400 (542 – 1898)	12 (5.44)	8.9 (225)	1.75 (44)	1/2 (13)	60 (1699)
2925B2Ti	1" square	Through-hole socket retainer	Grip I.T.	6,500	900	1,600 (2169)	350 – 1,250 (475 – 1695)	15.2 (6.89)	13.28 (334)	1.75 (44)	1/2 (13)	60 (1699)
2925RB2Ti	1" square reverse bias	Through-hole socket retainer	Grip I.T.	6,500	900	F: 1,500 (2333) R: 1,700 (2304)	F: 300 – 950 (407 – 1288) R: 400 – 1,400 (542 – 1898)	15.2 (6.89)	13.28 (334)	1.75 (44)	1/2 (13)	60 (1699)
2925P3Ti	1" square	Through-hole socket retainer	Pistol	5,200	1,050	1,450 (1966)	350 – 1,100 (475 – 1492)	12.2 (5.54)	9.04 (230)	1.74 (44)	1/2 (13)	60 (1699)
2925RBP3Ti	1" square reverse bias	Through-hole socket retainer	Pistol	5,200	1,050	F: 1,300 (1763) R: 1,600 (2169)	F: 300 – 950 (407 – 1288) R: 400 – 1,400 (542 – 1898)	12.2 (5.54)	9.04 (230)	1.74 (44)	1/2 (13)	60 (1699)



2934 Series











2934P2



2934B2

SUPER DUTY

- Cast iron hammer case
- Bronze endplates
- Twin hammer mechanism
- Pressure-fed mechanism lubrication
- Integral muffler
- 1/2" NPT inlet

Model	Description	Details	Handle									
				rpm	ft-lb (Nm)	ft-lb (Nm)	ft-lb (Nm)	lb (kg)	in (mm)	in (mm)	in (mm)	cfm
2934B2	1" square	Through-hole socket retainer	Grip I.T.	6,600	750	1,500 (2034)	500 – 1,100 (678 – 1491)	18.5 (8.39)	11.25 (286)	2.19 (56)	3/4 (19)	47 (1331)
2934B9	1" square at 90°	Through-hole socket retainer	Grip I.T.	5,300	780	750 (1017)	250 – 500 (339 – 678)	35.75 (16.2)	18.63 (473)	1.63 (41)	3/4 (19)	47 (1331)
2934P2	1" square	Through-hole socket retainer	Pistol	5,300	825	1,500 (2034)	500 – 1,100 (678 – 1491)	20 (9.07)	8.63 (219)	2.19 (56)	3/4 (19)	47 (1331)

3940Ti Series











3940P2Ti



3940B2Ti

SUPER DUTY

- Titanium hammer case
- Bronze endplates
- Twin hammer mechanism
- Reverse bias motor
- Pressure-fed mechanism lubrication
- Integral muffler
- 1/2" NPT inlet

Model	Description	Details	Handle									
				rpm	ft-lb (Nm)	ft-lb (Nm)	ft-lb (Nm)	lb (kg)	in (mm)	in (mm)	in (mm)	cfm
3940A1Ti	No. 5 spline	Through-hole socket retainer	Grip O.T.	6,000	800	2,500 (3390)	F: 500 – 1,650 (680 – 2240) R: 500 – 1,800 (680 – 2440)	21.2 (9.6)	13.4 (341)	2.3 (59)	3/4 (19)	75 (2124)
3940A2Ti	1" square	Through-hole socket retainer	Grip O.T.	6,000	800	2,500 (3390)	F: 500 – 1,650 (680 – 2240) R: 500 – 1,800 (680 – 2440)	21.2 (9.6)	13.4 (341)	2.3 (59)	3/4 (19)	75 (2124)
3940B1Ti	No. 5 spline	Through-hole socket retainer	Grip I.T.	6,000	800	2,500 (3390)	F: 500 – 1,650 (680 – 2240) R: 500 – 1,800 (680 – 2440)	21.2 (9.6)	13.4 (341)	2.3 (59)	3/4 (19)	75 (2124)
3940B2Ti	1" square	Through-hole socket retainer	Grip I.T.	6,000	800	2,500 (3390)	F: 500 – 1,650 (680 – 2240) R: 500 – 1,800 (680 – 2440)	21.2 (9.6)	13.4 (341)	2.3 (59)	3/4 (19)	75 (2124)
3940P2Ti	1" square	Through-hole socket retainer	Pistol	5,300	800	2,500 (3390)	F: 500 – 1,650 (680 – 2240) R: 500 – 1,800 (680 – 2440)	20.4 (9.3)	10.1 (256)	2.3 (59)	3/4 (19)	75 (2124)



3942Ti Series



3942B2Ti



3942A2Ti

SUPER DUTY

- Titanium hammer case
- Bronze endplates
- Twin hammer mechanism
- Reverse bias motor
- Pressure-fed mechanism lubrication
- Integral muffler
- 1/2" NPT inlet

Model	Description	Details	Handle	1 min.	1 min.	Max. ft-lbs	ft-lb	lb (kg)	in (mm)	in (mm)	in (mm)	cfm
				rpm		ft-lb (Nm)	ft-lb (Nm)					
3942A2Ti	1" square	Through-hole socket retainer	Grip O.T.	5,000	850	3,250 (4406)	F: 1,000 – 1,950 (1356 – 2644) R: 1,000 – 2,100 (1356 – 2848)	22.6 (10.5)	14.2 (361)	2.3 (59)	3/4 (19)	95 (2690)
3942B1Ti	No. 5 spline	Through-hole socket retainer	Grip I.T.	5,000	850	3,250 (4406)	F: 1,000 – 1,950 (1356 – 2644) R: 1,000 – 2,100 (1356 – 2848)	22.6 (10.5)	14.2 (361)	2.3 (59)	3/4 (19)	95 (2690)
3942B2Ti	1" square	Through-hole socket retainer	Grip I.T.	5,000	850	3,250 (4406)	F: 1,000 – 1,950 (1356 – 2644) R: 1,000 – 2,100 (1356 – 2848)	22.6 (10.5)	14.2 (361)	2.3 (59)	3/4 (19)	95 (2690)

Tune-up kits

Part Number	For Use With
3/4" TO 1-1/2" IMPACTOOL	
2141-TK1	2141, 2141P
2161-TK2	2161XP, 2161P 2171XP, 2171P
1720B-TK2	1720B1, 1720B3
1720P-TK2	1720P1, 1720P3
1712B/1712P-TK3	1712B2
2920B-TK2	2920 Series
2920P-TK2	2920 Series
2925B-TK2	2925Ti Series
2934-TK3	2934 Series
3940-TK1	3940Ti Series
3942-TK1	3942Ti Series
3955-TK1	3955Ti Series

Hammer kits

Part Number	For Use With
3/4" & 1" IMPACTOOL	
2141-THK1	2100 Series

Anvils & hangers

Part Number	Description	For Use With
3/4" & 1" IMPACTOOL		
1712-A526	Spline drive anvil assembly	1712B2
2910B-A926-10	Quick change anvil assembly	2920 Series
2910-A526	#4 spline drive anvil assembly	2920 Series & 2925 Series
2934-A526	Spline drive anvil assembly	2934 Series
2161-366	Horizontal hanger	2161/71 & 2925Ti Series
910-366	Horizontal hanger	1720/2920 Series
2934-366	Horizontal hanger	1712B2 & 2934 Series



Note: Ingersoll Rand lubricants & greases are available to fulfill maintenance needs.



3955Ti Series



SUPER DUTY

- Titanium hammer case
- Bronze endplates
- Twin hammer mechanism
- Reverse bias motor
- Pressure-fed mechanism lubrication
- Integral muffler
- 1/2" NPT inlet

Model	Description	Details	Handle	rpm	ft-lb (Nm)	ft-lb (Nm)	ft-lb (Nm)	lb (kg)	in (mm)	in (mm)	in (mm)	cfm
3955A2Ti	1-1/2" square	Through-hole socket retainer	Grip O.T.	2,750	700	5,000 (6779)	F: 1,600 – 3,900 (2169 – 5288) R: 1,600 – 4,150 (2170 – 5630)	34.6 (15.7)	16.65 (423)	2.67 (68)	3/4 (19)	80 (2265)
3955B1Ti	No. 5 spline	Through-hole socket retainer	Grip I.T.	2,750	700	5,000 (6779)	F: 1,600 – 3,900 (2169 – 5288) R: 1,600 – 4,150 (2170 – 5630)	34.6 (15.7)	16.65 (423)	2.67 (68)	3/4 (19)	80 (2265)
3955B2Ti	1-1/2" square	Through-hole socket retainer	Grip I.T.	2,750	700	5,000 (6779)	F: 1,600 – 3,900 (2169 – 5288) R: 1,600 – 4,150 (2170 – 5630)	34.6 (15.7)	16.65 (423)	2.67 (68)	3/4 (19)	80 (2265)

5000 Series

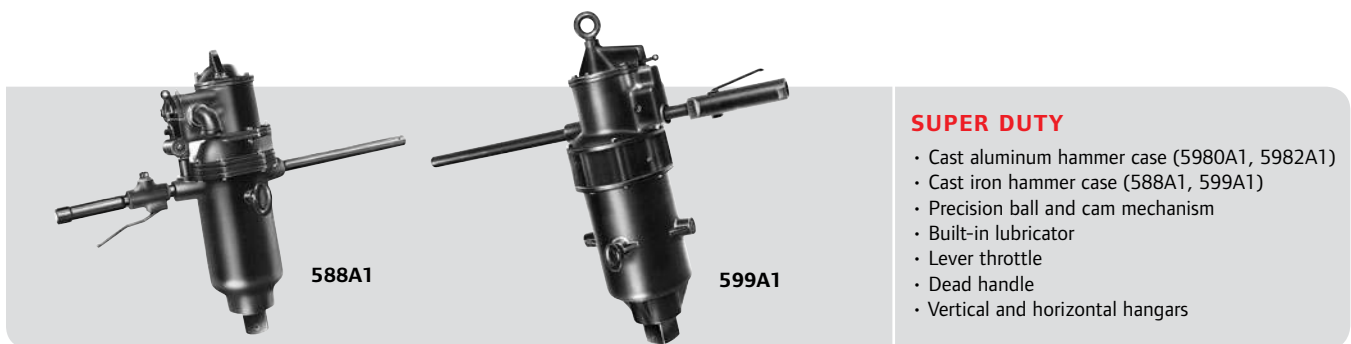

SUPER DUTY

- Cast aluminum hammer case (5980A1, 5982A1)
- Cast iron hammer case (588A1, 599A1)
- Precision ball and cam mechanism
- Built-in lubricator
- Lever throttle
- Dead handle
- Vertical and horizontal hangars

Model	Description	Details	Handle	rpm	ft-lb (Nm)	ft-lb (Nm)	ft-lb (Nm)	lb (kg)	in (mm)	in (mm)	in (mm)	cfm
5980A1	1-1/2" square	3/4" NPT Inlet	Lever	830	1,000	10,000 (13560)	2,300 – 5,500 (3119 – 7460)	88 (39.9)	23 (584)	3.06 (78)	1 (25)	138 (3908)
5982A1	2-1/2" square	3/4" NPT Inlet	Lever	830	850	20,000 (27120)	4,000 – 10,000 (5424 – 13560)	120 (54.5)	25.38 (645)	3.5 (90)	1 (25)	130 (3681)
588A1	2-1/2" square	1" NPT Inlet	Lever	355	550	50,000 (67800)	12,000 – 25,000 (16270 – 33900)	215 (97.5)	26.63 (676)	4 (101)	1 (25)	155 (4389)
599A1	3-1/2" square	1-1/4" NPT Inlet	Lever	295	500	80,000 (108500)	26,000 – 42,000 (35250 – 57000)	599 (272)	37.5 (952)	6.75 (171)	1-1/2 (38)	375 (10619)

Cordless Impacttools



Cordless for pros

As a world leader in enhancing productivity, Ingersoll Rand is the only company offering cordless tools specifically engineered for industrial MRO tool users. Our cordless tools deliver portability with the reliability of advanced battery/charger technologies and proven Ingersoll Rand power and durability.

With Ingersoll Rand you get cordless tools that work as hard as you. You can literally take them and run ... and run and run.

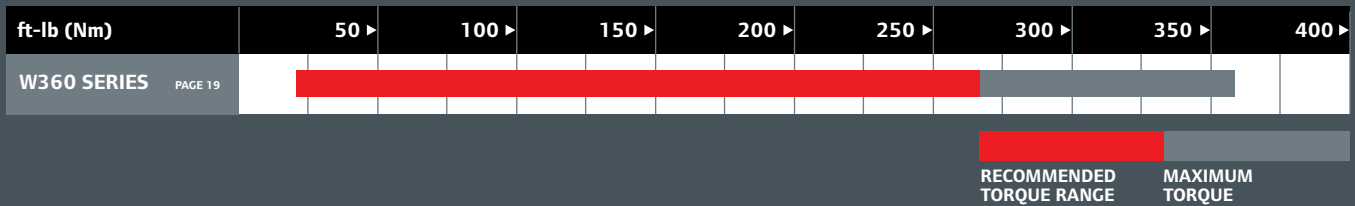

W360 Series



W360 available in one or two battery kits

W360

W360-2

IQV™ WARRANTY

1 Year No-fee Tool & Charger Replacement	2 Year or 1,000 Recharges Battery Limited Warranty	3 Year Limited Warranty Tools & Chargers
--	---	---

REGISTRATION REQUIRED (irtools.com)
See irtools.com for Official Terms & Conditions
May vary by country.

IR Ingersoll Rand

Model	Description	Volts	Max ft-lbs ft-lb (Nm)	ft-lb (Nm)	1 min. rpm	m/s ²	1 min 1/min	W / Battery lb (kg)	L in (mm)	Headphones dBA
W360	1/2" square hog ring	19.2	360 (488)	25 - 280 (33 - 379)	1,650	11.2	2,200	6.2 (2.8)	9 (228.6)	92.3 / 103.3
W360P	1/2" square pin-type	19.2	360 (488)	25 - 280 (33 - 379)	1,650	11.2	2,200	6.2 (2.8)	9 (228.6)	92.3 / 103.3
W360-2	1/2" square hog ring, 2" extended	19.2	360 (488)	25 - 280 (33 - 379)	1,650	11.2	2,200	6.2 (2.8)	10-7/8 (275)	92.3 / 103.3

All-metal hammer case

360 ft-lb max reverse torque

Extreme durability

All-metal gear train

Variable speed trigger

Robust housing design delivers exceptional strength with minimal weight.

Drop-resistant, steel reinforced frame protects against breakage where tools are most vulnerable

Engineered composite housing stands up to harsh chemicals and fluids

IQV™ grip battery with patented twist-to-lock grip mount eliminates wear and tear common with competitive battery mounts

Aluminum housing retainer ring

To see the full line of IQV Series™ cordless products, please visit ingersollrandproducts.com.

Accessories



Match the best
tools with the best
accessories

When there's a demanding job to do, you need tools and accessories that are going to work as hard as you do. That's exactly what you get when you turn to Ingersoll Rand.

Our complete line of tool-related accessories reflects the same high performance standards you expect from Ingersoll Rand — the global leader for durable and reliable tools and equipment.

Impact Sockets



3/8" Impact Sockets

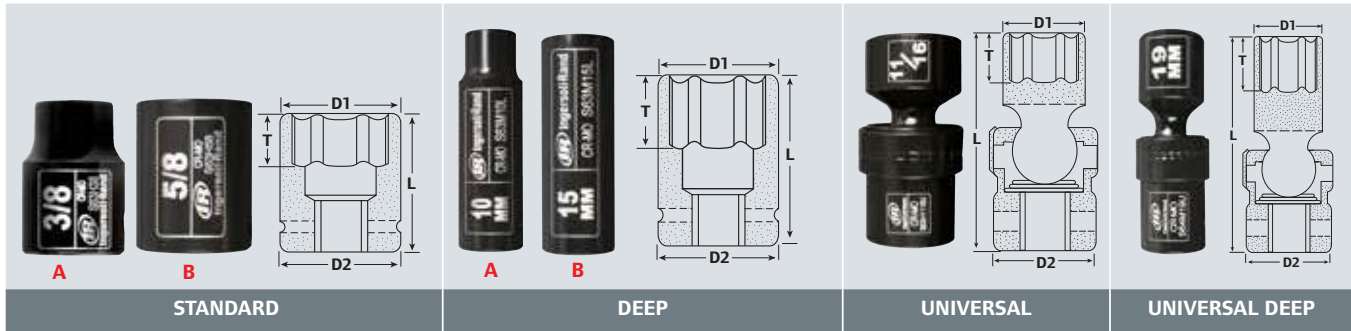

Individuals

6-PT							
Part Number	Output Size	Description	D1 in (mm)	D2 in (mm)	T in (mm)	L in (mm)	Type
S63H14	1/4"	Standard	0.43 (11)	0.75 (19)	0.16 (4)	1.1 (28)	A
S63H516	5/16"	Standard	0.49 (12.5)	0.75 (19)	0.28 (7)	1.1 (28)	A
S63H38	3/8"	Standard	0.57 (14.5)	0.75 (19)	0.28 (7)	1.1 (28)	A
S63H716	7/16"	Standard	0.67 (17)	0.75 (19)	0.28 (7)	1.18 (30)	A
S63H12	1/2"	Standard	0.75 (19)	0.75 (19)	0.28 (7)	1.18 (30)	B
S63H916	9/16"	Standard	0.79 (20)	0.79 (20)	0.28 (7)	1.18 (30)	B
S63H58	5/8"	Standard	0.94 (24)	0.94 (24)	0.39 (10)	1.18 (30)	B
S63H1116	11/16"	Standard	0.94 (24)	0.94 (24)	0.39 (10)	1.26 (32)	B
S63H516L	5/16"	Deep	0.49 (12.5)	0.75 (19)	0.47 (12)	2.48 (63)	A
S63H38L	3/8"	Deep	0.57 (14.5)	0.75 (19)	0.55 (14)	2.48 (63)	A
S63H716L	7/16"	Deep	0.67 (17)	0.75 (19)	0.67 (17)	2.48 (63)	A
S63H12L	1/2"	Deep	0.75 (19)	0.75 (19)	0.67 (17)	2.48 (63)	B
S63H916L	9/16"	Deep	0.79 (20)	0.79 (20)	0.67 (17)	2.48 (63)	B
S63H58L	5/8"	Deep	0.94 (24)	0.94 (24)	0.67 (17)	2.48 (63)	B
S63H1116L	11/16"	Deep	0.94 (24)	0.94 (24)	0.67 (17)	2.48 (63)	B
S63M10L	10mm	Deep	0.59 (15)	0.75 (19)	0.55 (14)	2.48 (63)	A
S63H516U	5/16"	Universal	0.69 (17.5)	0.94 (24)	0.47 (12)	2.09 (53)	A
S63H38U	3/8"	Universal	0.59 (15)	0.94 (24)	0.47 (12)	2.09 (53)	A
S63H716U	7/16"	Universal	0.73 (18.5)	0.94 (24)	0.47 (12)	2.09 (53)	A
S63H12U	1/2"	Universal	0.75 (19)	0.94 (24)	0.47 (12)	2.09 (53)	A
S63H916U	9/16"	Universal	0.87 (22)	0.94 (24)	0.47 (12)	2.09 (53)	A
S63H58U	5/8"	Universal	0.94 (24)	0.94 (24)	0.47 (12)	2.09 (53)	A
S63H1116U	11/16"	Universal	0.98 (25)	0.94 (24)	0.47 (12)	2.09 (53)	A
S63H516UL	5/16"	Universal Deep	0.69 (17.5)	0.94 (24)	0.51 (13)	3.03 (77)	A
S63H38UL	3/8"	Universal Deep	0.71 (18)	0.94 (24)	0.51 (13)	3.03 (77)	A
S63H716UL	7/16"	Universal Deep	0.71 (18)	0.94 (24)	0.51 (13)	3.03 (77)	A

Additional individual sockets (English and Metric) and an array of sets are available for each drive size. See the Accessories Catalog IRITS-0810-069 or ingersollrandproducts.com/accessories for details.

ingersollrandproducts.com

6-PT

Part Number	Output Size	Description	D1 in (mm)	D2 in (mm)	T in (mm)	L in (mm)	Type
S63H12UL	1/2"	Universal Deep	0.75 (19)	0.94 (24)	0.51 (13)	3.03 (77)	A
S63H916UL	9/16"	Universal Deep	0.83 (21)	0.94 (24)	0.51 (13)	3.03 (77)	A
S63H58UL	5/8"	Universal Deep	0.91 (23)	0.94 (24)	0.51 (13)	3.03 (77)	A
S63H1116UL	11/16"	Universal Deep	0.98 (25)	0.94 (24)	0.51 (13)	3.03 (77)	A

Accessories

Output Size	Description	Retaining Ring
A3F2M	3/8" F to 1/4" M Adapter	RR10003
A3F4M	3/8" F to 1/2" M Adapter	RR10003
J3	Universal Joint	—
E33H	3" Extension	RR10003
E36H	6" Extension	RR10003
E312H	12" Extension	RR10003



Adapter



Extension

1/2" Impact Sockets

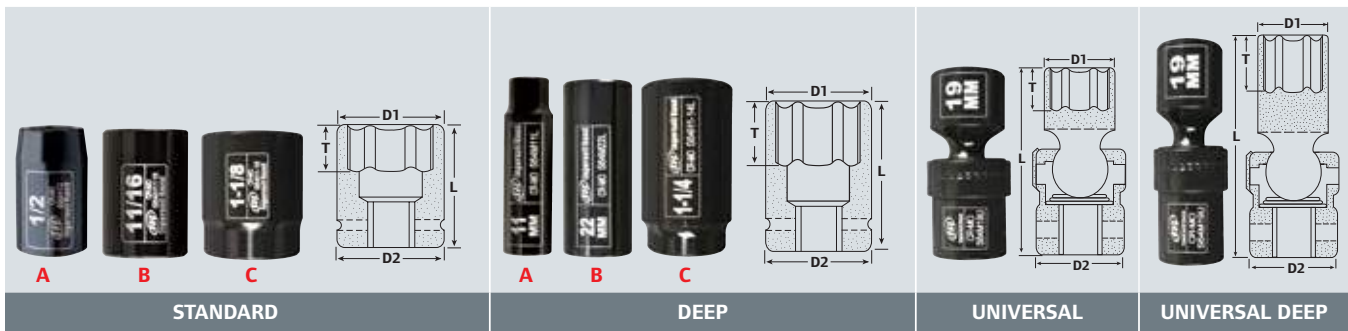
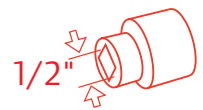

Individuals

6-PT

Part Number	Output Size	Description	D1 in (mm)	D2 in (mm)	T in (mm)	L in (mm)	Type
S64H916	9/16"	Standard	0.85 (21.5)	0.94 (24)	0.43 (11)	1.5 (38)	A
S64H58	5/8"	Standard	0.94 (24)	0.94 (24)	0.43 (11)	1.5 (38)	B
S64H1116	11/16"	Standard	1.02 (26)	1.02 (26)	0.43 (11)	1.5 (38)	B
S64H34	3/4"	Standard	1.1 (28)	1.1 (28)	0.63 (16)	1.57 (40)	B
S64H1316	13/16"	Standard	1.18 (30)	1.18 (30)	0.63 (16)	1.57 (40)	B
S64H78	7/8"	Standard	1.26 (32)	1.26 (32)	0.63 (16)	1.65 (42)	B

6-PT

Part Number	Output Size	Description	D1 in (mm)	D2 in (mm)	T in (mm)	L in (mm)	Type
S64H1516	15/16"	Standard	1.34 (34)	1.34 (34)	0.63 (16)	1.73 (44)	B
S64H1	1"	Standard	1.42 (36)	1.42 (36)	0.71 (18)	1.73 (44)	B
S64H1-116	1-1/16"	Standard	1.5 (38)	1.5 (38)	0.71 (18)	1.81 (46)	B
S64H916L	9/16"	Deep	0.87 (22)	0.94 (24)	0.55 (14)	3.07 (78)	A
S64H58L	5/8"	Deep	0.94 (24)	0.94 (24)	0.55 (14)	3.07 (78)	B
S64H1116L	11/16"	Deep	1.02 (26)	1.02 (26)	0.67 (17)	3.07 (78)	B
S64H34L	3/4"	Deep	1.1 (28)	1.1 (28)	0.67 (17)	3.07 (78)	B
S64H1316L	13/16"	Deep	1.18 (30)	1.18 (30)	0.67 (17)	3.07 (78)	B
S64H78L	7/8"	Deep	1.26 (32)	1.26 (32)	0.75 (19)	3.07 (78)	B
S64H1516L	15/16"	Deep	1.34 (34)	1.34 (34)	0.75 (19)	3.07 (78)	B
S64H1L	1"	Deep	1.42 (36)	1.42 (36)	0.75 (19)	3.07 (78)	B
S64H1-116L	1-1/16"	Deep	1.5 (38)	1.5 (38)	0.75 (19)	3.07 (78)	B
S64H916U	9/16"	Universal	0.87 (22)	1.1 (28)	0.51 (13)	2.6 (66)	A
S64H58U	5/8"	Universal	0.94 (24)	1.1 (28)	0.51 (13)	2.6 (66)	A
S64H1116U	11/16"	Universal	1.02 (26)	1.1 (28)	0.51 (13)	2.6 (66)	A
S64H34U	3/4"	Universal	1.1 (28)	1.1 (28)	0.51 (13)	2.6 (66)	A
S64H1316U	13/16"	Universal	1.18 (30)	1.1 (28)	0.51 (13)	2.6 (66)	A
S64H78U	7/8"	Universal	1.26 (32)	1.1 (28)	0.51 (13)	2.6 (66)	A
S64H1516U	15/16"	Universal	1.42 (36)	1.1 (28)	0.51 (13)	2.6 (66)	A
S64H916UL	9/16"	Universal Deep	0.87 (22)	1.1 (28)	0.67 (17)	3.54 (90)	A
S64H58UL	5/8"	Universal Deep	0.94 (24)	1.1 (28)	0.67 (17)	3.54 (90)	A
S64H1116UL	11/16"	Universal Deep	1.02 (26)	1.1 (28)	0.67 (17)	3.54 (90)	A
S64H34UL	3/4"	Universal Deep	1.1 (28)	1.1 (28)	0.67 (17)	3.54 (90)	A
S64H1316UL	13/16"	Universal Deep	1.18 (30)	1.1 (28)	0.67 (17)	3.54 (90)	A
S64H78UL	7/8"	Universal Deep	1.26 (32)	1.1 (28)	0.67 (17)	3.54 (90)	A
S64H1516UL	15/16"	Universal Deep	1.34 (34)	1.1 (28)	0.67 (17)	3.54 (90)	A

Accessories

	Output Size	Description	Retaining Ring 
A4F3M	3/8"	1/2" F to 3/8" M Adapter	RR10006
A4F6M	3/4"	1/2" F to 3/4" M Adapter	RR10008
J4	1/2"	Universal Joint	—
E43H	1/2"	3" Extension	RR10006
E45H	1/2"	5" Extension	RR10006
E47H	1/2"	7" Extension	RR10006
E410H	1/2"	10" Extension	RR10006
E418H	1/2"	18" Extension	RR10006
E424H	1/2"	24" Extension	RR10006
E436H	1/2"	36" Extension	RR10006



Adapter



Extension



Extension

3/4" Impact Sockets

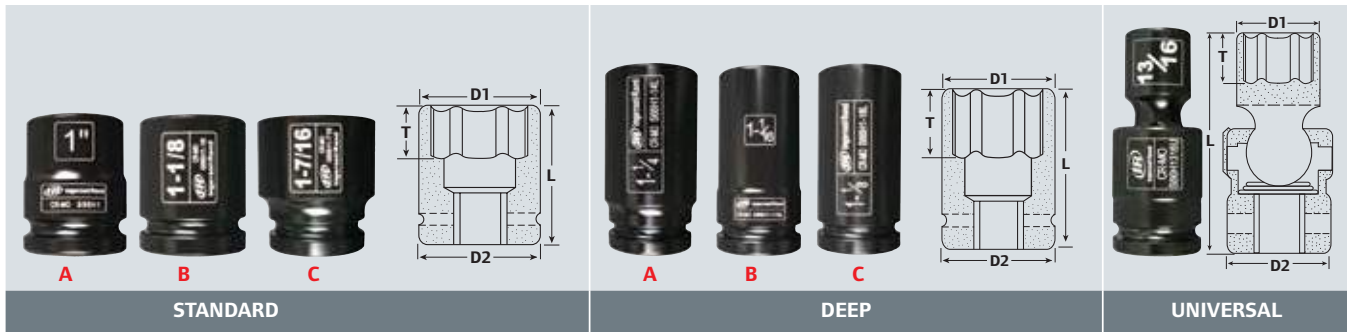

Individuals

6-PT									Retaining Ring
Part Number	Output Size	Description	D1 in (mm)	D2 in (mm)	T in (mm)	L in (mm)	Type		
S66H1516	15/16"	Standard	1.52 (38.5)	1.63 (41.4)	0.51 (13)	2.01 (51)	A	RR10010	
S66H1	1"	Standard	1.57 (40)	1.63 (41.4)	0.51 (13)	2.09 (53)	A	RR10010	
S66H1-116	1-1/16"	Standard	1.67 (42.5)	1.73 (44)	0.51 (13)	2.09 (53)	A	RR10034S	
S66H1-18	1-1/8"	Standard	1.73 (44)	1.73 (44)	0.63 (16)	2.09 (53)	B	RR10034S	
S66H1-316	1-3/16"	Standard	1.81 (46)	1.73 (44)	0.63 (16)	2.09 (53)	C	RR10034S	
S66H1-14	1-1/4"	Standard	1.89 (48)	1.73 (44)	0.63 (16)	2.24 (57)	C	RR10034S	
S66H1-516	1-5/16"	Standard	1.97 (50)	1.73 (44)	0.75 (19)	2.24 (57)	C	RR10034S	
66H1-38	1-3/8"	Standard	2.07 (52.5)	1.73 (44)	0.75 (19)	2.24 (57)	C	RR10034S	
S66H1-716	1-7/16"	Standard	2.11 (53.5)	1.73 (44)	0.75 (19)	2.24 (57)	C	RR10034S	
S66H1-12	1-1/2"	Standard	2.2 (56)	1.73 (44)	0.87 (22)	2.24 (57)	C	RR10034S	
S66H1-916	1-9/16"	Standard	2.3 (58.5)	1.73 (44)	0.87 (22)	2.28 (58)	C	RR10034S	
S66H1-58	1-5/8"	Standard	2.36 (60)	1.73 (44)	0.87 (22)	2.28 (58)	C	RR10034S	
S66H1-1116	1-11/16"	Standard	2.5 (63.5)	1.73 (44)	1.02 (26)	2.44 (62)	C	RR10034S	
S66H1-34	1-3/4"	Standard	2.54 (64.5)	1.73 (44)	1.02 (26)	2.44 (62)	C	RR10034S	
S66H1-1316	1-13/16"	Standard	2.6 (66)	1.73 (44)	1.02 (26)	2.44 (62)	C	RR10034S	
S66H1516L	15/16"	Deep	1.52 (38.5)	1.63 (41.4)	0.63 (16)	3.54 (90)	A	RR10010	
S66H1L	1"	Deep	1.57 (40)	1.63 (41.4)	0.63 (16)	3.54 (90)	A	RR10010	
S66H1-116L	1-1/16"	Deep	1.67 (42.5)	1.73 (44)	0.63 (16)	3.54 (90)	A	RR10034S	
S66H1-18L	1-1/8"	Deep	1.73 (44)	1.73 (44)	0.63 (16)	3.54 (90)	B	RR10034S	
S66H1-316L	1-3/16"	Deep	1.81 (46)	1.73 (44)	0.63 (16)	3.54 (90)	C	RR10034S	
S66H1-14L	1-1/4"	Deep	1.91 (48.5)	1.73 (44)	0.63 (16)	3.54 (90)	C	RR10034S	
S66H1-516L	1-5/16"	Deep	1.97 (50)	1.73 (44)	0.87 (22)	3.54 (90)	C	RR10034S	
S66H1-38L	1-3/8"	Deep	2.07 (52.5)	1.73 (44)	0.87 (22)	3.54 (90)	C	RR10034S	
S66H1-716L	1-7/16"	Deep	2.11 (53.5)	1.73 (44)	0.87 (22)	3.54 (90)	C	RR10034S	
S66H1-12L	1-1/2"	Deep	2.2 (56)	1.73 (44)	0.87 (22)	3.54 (90)	C	RR10034S	
S66H1-916L	1-9/16"	Deep	2.3 (58.5)	1.73 (44)	0.87 (22)	3.54 (90)	C	RR10034S	
S66H1-58L	1-5/8"	Deep	2.36 (60)	1.73 (44)	0.87 (22)	3.54 (90)	C	RR10034S	
S66H1-1116L	1-11/16"	Deep	2.5 (63.5)	1.73 (44)	1.06 (27)	3.54 (90)	C	RR10034S	

Oriore, nis sedis endel miliquia posant.

Enim quodignima quam quatus antotatas inctur anihillam aut quas atur maiorit estibus, sim fugia quunt quasit ario bea velecab oreseque disquat iusam, quod quatemp elliqui nimpost ididem idebita sinciende pla pratur re dit velligenimus magnimi nvelian dandigentum volor sed que ea picimus santur, sam quis sit modia alit as explibusda que verchil eum explate volorest quatem fuga. Nam qui sintemp idrate tubecum bu diceseq dolutpa solestran, is pore, iuscium rerite verovit ape dit que doluptae volutem. Namet lamus alit reped quatectate ducis idicipsa cum es sectis voluptatus.

Additional individual sockets (English and Metric) and an array of sets are available for each drive size. See the Accessories Catalog IRIS-0810-069 or www.impacttools.com for details.

6-PT								Retaining Ring
Part Number	Output Size	Description	D1 in (mm)	D2 in (mm)	T in (mm)	L in (mm)	Type	
S66H1-34L	1-3/4"	Deep	2.54 (64.5)	1.73 (44)	1.06 (27)	3.54 (90)	C	RR10034S
S66H1-1316L	1-13/16"	Deep	2.6 (66)	1.73 (44)	1.06 (27)	3.54 (90)	C	RR10034S
S66H1516U	15/16"	Universal	1.54 (39)	1.73 (44)	0.51 (13)	3.74 (95)	A	RR10034S
S66H1U	1"	Universal	1.61 (41)	1.73 (44)	0.51 (13)	3.94 (100)	A	RR10034S
S66H1-116U	1-1/16"	Universal	1.69 (43)	1.73 (44)	0.67 (17)	3.94 (100)	A	RR10034S
S66H1-18U	1-1/8"	Universal	1.73 (44)	1.73 (44)	0.67 (17)	3.94 (100)	A	RR10034S
S66H1-316U	1-3/16"	Universal	1.85 (47)	1.73 (44)	0.67 (17)	3.94 (100)	A	RR10034S
S66H1-14U	1-1/4"	Universal	1.93 (49)	1.73 (44)	0.67 (17)	4.13 (105)	A	RR10034S
S66H1-516U	1-5/16"	Universal	2.01 (51)	1.73 (44)	0.75 (19)	4.13 (105)	A	RR10034S
S66H1-38U	1-3/8"	Universal	2.09 (53)	1.73 (44)	0.75 (19)	4.13 (105)	A	RR10034S
S66H1-716U	1-7/16"	Universal	2.13 (54)	1.73 (44)	0.75 (19)	4.33 (110)	A	RR10034S
S66H1-12U	1-1/2"	Universal	2.24 (57)	1.73 (44)	0.87 (22)	4.33 (110)	A	RR10034S
S66H1-916U	1-9/16"	Universal	2.36 (60)	1.73 (44)	0.87 (22)	4.33 (110)	A	RR10034S
S66H1-58U	1-5/8"	Universal	2.36 (60)	1.73 (44)	0.87 (22)	4.53 (115)	A	RR10034S
S66H1-1116U	1-11/16"	Universal	2.48 (63)	1.73 (44)	1.06 (27)	4.53 (115)	A	RR10034S
S66H1-34U	1-3/4"	Universal	2.52 (64)	1.73 (44)	1.06 (27)	4.53 (115)	A	RR10034S
S66H1-1316U	1-13/16"	Universal	2.6 (66)	1.73 (44)	1.06 (27)	4.53 (115)	A	RR10034S

Accessories

			Retaining Ring
Output Size	Description		
A6F4M	1/2"	3/4" F to 1/2" M Adapter	RR10034S
A6F8M	1"	3/4" F to 1" M Adapter	RR10034S
A6F55M	#5 Spline	3/4" F to #5 Spline M Adapter	RR10034S
J6	3/4"	Universal Joint	RR10034S
E63H	3/4"	3" Extension	RR10034S
E67H	3/4"	7" Extension	RR10034S
E610H	3/4"	10" Extension	RR10034S
E613H	3/4"	13" Extension	RR10034S



Adapter



Extension

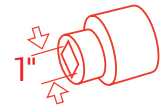

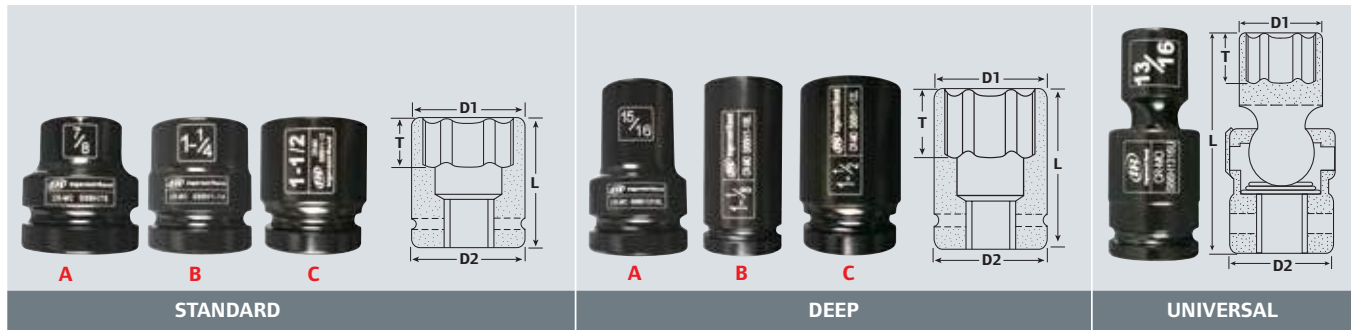

1" Impact Sockets



Individuals

6-PT								Retaining Ring	
Part Number	Output Size	Description	D1 in (mm)	D2 in (mm)	T in (mm)	L in (mm)	Type		
S68H1-18	1-1/8"	Standard	1.81 (46)	2.13 (54)	0.67 (17)	2.44 (62)	A	RR10015S	
S68H1-316	1-3/16"	Standard	1.93 (49)	2.13 (54)	0.67 (17)	2.44 (62)	A	RR10015S	
S68H1-14	1-1/4"	Standard	2.03 (51.5)	2.13 (54)	0.67 (17)	2.48 (63)	A	RR10015S	
S68H1-516	1-5/16"	Standard	2.13 (54)	2.13 (54)	0.75 (19)	2.48 (63)	B	RR10015S	
SS68H1-38	1-3/8"	Standard	2.17 (55)	2.13 (54)	0.75 (19)	2.6 (66)	C	RR10015S	
S68H1-716	1-7/16"	Standard	2.22 (56.5)	2.13 (54)	0.75 (19)	2.6 (66)	C	RR10015S	
S68H1-12	1-1/2"	Standard	2.32 (59)	2.13 (54)	0.87 (22)	2.6 (66)	C	RR10015S	
S68H1-916	1-9/16"	Standard	2.4 (61)	2.13 (54)	0.87 (22)	2.6 (66)	C	RR10015S	
S68H1-58	1-5/8"	Standard	2.46 (62.5)	2.13 (54)	0.87 (22)	2.68 (68)	C	RR10015S	
S68H1-1116	1-11/16"	Standard	2.56 (65)	2.13 (54)	0.98 (25)	2.76 (70)	C	RR10015S	
S68H1-34	1-3/4"	Standard	2.66 (67.5)	2.37 (60.3)	0.98 (25)	2.76 (70)	C	RR10015S	
S68H1-1316	1-13/16"	Standard	2.72 (69)	2.37 (60.3)	1.06 (27)	2.83 (72)	C	RR10015S	
S68H1-78	1-7/8"	Standard	2.76 (70)	2.37 (60.3)	1.06 (27)	2.83 (72)	C	RR10015S	
S68H1-1516	1-15/16"	Standard	2.85 (72.5)	2.37 (60.3)	1.06 (27)	2.99 (76)	C	RR10015S	
S68H2	2"	Standard	2.91 (74)	2.37 (60.3)	1.06 (27)	2.99 (76)	C	RR10015S	
S68H2-116	2-1/16"	Standard	3.01 (76.5)	2.37 (60.3)	1.22 (31)	3.15 (80)	C	RR10015S	
S68H2-18	2-1/8"	Standard	3.11 (79)	2.37 (60.3)	1.22 (31)	3.15 (80)	C	RR10015S	
S68H2-316	2-3/16"	Standard	3.15 (80)	2.37 (60.3)	1.22 (31)	3.31 (84)	C	RR10015S	
S68M41	41"	Standard	2.46 (62.5)	2.13 (54)	0.98 (25)	2.68 (68)	C	RR10015S	
S68M42	42"	Standard	2.52 (64)	2.13 (54)	0.98 (25)	2.68 (68)	C	RR10015S	
S68M43	43"	Standard	2.56 (65)	2.13 (54)	0.98 (25)	2.76 (70)	C	RR10015S	
S68M45	45"	Standard	2.66 (67.5)	2.13 (54)	0.98 (25)	2.76 (70)	C	RR10015S	
S68M46	46"	Standard	2.72 (69)	2.13 (54)	1.14 (29)	2.83 (72)	C	RR10015S	
S68M48	48"	Standard	2.81 (71.5)	2.13 (54)	1.14 (29)	2.99 (76)	C	RR10015S	
S68M50	50"	Standard	2.91 (74)	2.13 (54)	1.22 (31)	2.99 (76)	C	RR10015S	
S68M52	52"	Standard	3.01 (76.5)	2.13 (54)	1.22 (31)	3.15 (80)	C	RR10015S	
S68M54	54"	Standard	3.11 (79)	2.13 (54)	1.22 (31)	3.15 (80)	C	RR10015S	
S68M55	55"	Standard	3.15 (80)	2.13 (54)	1.34 (34)	3.31 (84)	C	RR10015S	

 6-PT									Retaining Ring
Part Number	Output Size	Description	D1 in (mm)	D2 in (mm)	T in (mm)	L in (mm)	Type		
S68M56	56"	Standard	3.21 (81.5)	2.13 (54)	1.34 (34)	3.31 (84)	C	RR10015S	
S68H1-18L	1-1/8"	Deep	1.81 (46)	2.13 (54)	0.98 (25)	3.54 (90)	A	RR10015S	
S68H1-316L	1-3/16"	Deep	1.93 (49)	2.13 (54)	0.98 (25)	3.54 (90)	A	RR10015S	
S68H1-14L	1-1/4"	Deep	2.03 (51.5)	2.13 (54)	0.98 (25)	3.54 (90)	A	RR10015S	
S68H1-516L	1-5/16"	Deep	2.13 (54)	2.13 (54)	0.98 (25)	3.54 (90)	B	RR10015S	
S68H1-38L	1-3/8"	Deep	2.17 (55)	2.13 (54)	0.98 (25)	3.54 (90)	C	RR10015S	
S68H1-716L	1-7/16"	Deep	2.22 (56.5)	2.13 (54)	0.98 (25)	3.54 (90)	C	RR10015S	
S68H1-12L	1-1/2"	Deep	2.32 (59)	2.13 (54)	0.98 (25)	3.54 (90)	C	RR10015S	
S68H1-916L	1-9/16"	Deep	2.4 (61)	2.13 (54)	0.98 (25)	3.54 (90)	C	RR10015S	
S68H1-58L	1-5/8"	Deep	2.46 (62.5)	2.13 (54)	0.98 (25)	3.54 (90)	C	RR10015S	
S68H1-1116L	1-11/16"	Deep	2.56 (65)	2.13 (54)	0.98 (25)	3.54 (90)	C	RR10015S	
S68H1-34L	1-3/4"	Deep	2.66 (67.5)	2.37 (60.3)	1.22 (31)	3.94 (100)	C	RR10015S	
S68H1-1316L	1-13/16"	Deep	2.72 (69)	2.37 (60.3)	1.22 (31)	3.94 (100)	C	RR10015S	
S68H1-78L	1-7/8"	Deep	2.76 (70)	2.37 (60.3)	1.22 (31)	3.94 (100)	C	RR10015S	
S68H1-1516L	1-15/16"	Deep	2.85 (72.5)	2.37 (60.3)	1.22 (31)	3.94 (100)	C	RR10015S	
S68H2L	2"	Deep	2.91 (74)	2.37 (60.3)	1.22 (31)	3.94 (100)	C	RR10015S	
S68H2-116L	2-1/16"	Deep	3.01 (76.5)	2.37 (60.3)	1.22 (31)	3.94 (100)	C	RR10015S	
S68H2-18L	2-1/8"	Deep	3.11 (79)	2.37 (60.3)	1.22 (31)	4.25 (108)	C	RR10015S	
S68H2-316L	2-3/16"	Deep	3.15 (80)	2.37 (60.3)	1.22 (31)	4.25 (108)	C	RR10015S	
S68H1-18U	1-1/8"	Universal	1.89 (48)	2.13 (54)	0.75 (19)	5.2 (132)	A	RR10015S	
S68H1-316U	1-3/16"	Universal	1.93 (49)	2.13 (54)	0.75 (19)	5.2 (132)	A	RR10015S	
S68H1-14U	1-1/4"	Universal	2.01 (51)	2.13 (54)	0.75 (19)	5.2 (132)	A	RR10015S	
S68H1-516U	1-5/16"	Universal	2.09 (53)	2.13 (54)	0.75 (19)	5.2 (132)	A	RR10015S	
S68H1-38U	1-3/8"	Universal	2.17 (55)	2.13 (54)	0.75 (19)	5.2 (132)	A	RR10015S	
S68H1-716U	1-7/16"	Universal	2.28 (58)	2.13 (54)	0.75 (19)	5.2 (132)	A	RR10015S	
S68H1-12U	1-1/2"	Universal	2.32 (59)	2.13 (54)	0.98 (25)	5.39 (137)	A	RR10015S	
S68H1-916U	1-9/16"	Universal	2.4 (61)	2.13 (54)	0.98 (25)	5.39 (137)	A	RR10015S	
S68H1-58U	1-5/8"	Universal	2.48 (63)	2.13 (54)	0.98 (25)	5.39 (137)	A	RR10015S	
S68H1-1116U	1-11/16"	Universal	2.56 (65)	2.13 (54)	0.98 (25)	5.39 (137)	A	RR10015S	
S68H1-34U	1-3/4"	Universal	2.64 (67)	2.13 (54)	0.98 (25)	5.39 (137)	A	RR10015S	
S68H1-1316U	1-13/16"	Universal	2.72 (69)	2.13 (54)	1.06 (27)	5.59 (142)	A	RR10015S	
S68H1-78U	1-7/8"	Universal	2.8 (71)	2.13 (54)	1.06 (27)	5.59 (142)	A	RR10015S	
S68H1-1516U	1-15/16"	Universal	2.83 (72)	2.13 (54)	1.06 (27)	5.59 (142)	A	RR10015S	

Accessories

			Retaining Ring Ⓢ
	Output Size	Description	
A8F6M	3/4"	1" F to 3/4" M Adapter	RR10015S
A8F12M	1-1/2"	1" F to 1-1/2" M Adapter	RR10015S
A8F55M	#5 Spline	1" F to #5 Spline M Adapter	RR10015S
J8	1"	Universal Joint	RR10015S
E83H	1"	3" Extension	RR10015S
E87H	1"	7" Extension	RR10015S
E810H	1"	10" Extension	RR10015S
E813H	1"	13" Extension	RR10015S



Adapter



Extension

1-1/2" Impact Sockets

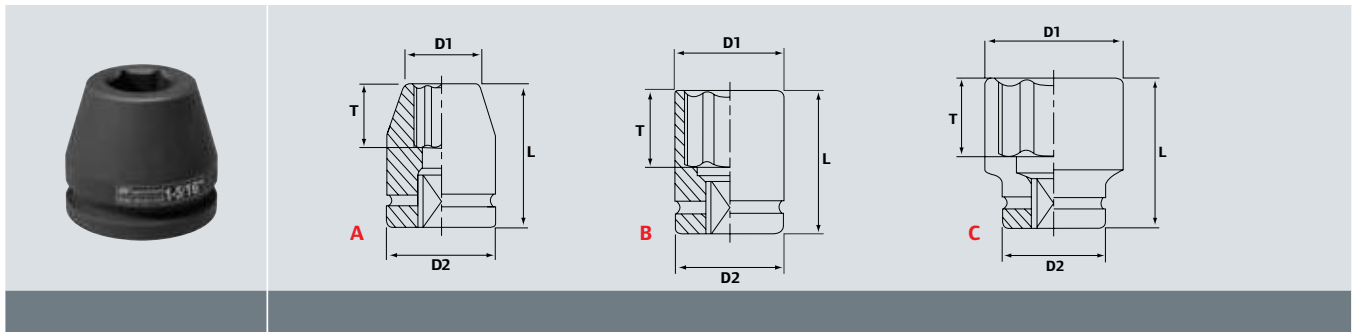
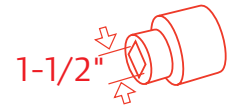

Individuals

6-PT							Retaining Ring		
Part Number	Output Size	Description	D1 in (mm)	D2 in (mm)	T in (mm)	L in (mm)	Type	Ⓢ	
S612H1-78L	1-7/8"	Deep	3.07 (78)	3.39 (86)	1.26 (32)	4.53 (115)	A	RR10025S	
S612H1-1516L	1-15/16"	Deep	3.15 (80)	3.39 (86)	1.26 (32)	4.53 (115)	A	RR10025S	
S612H2L	2"	Deep	3.23 (82)	3.39 (86)	1.34 (34)	5.31 (135)	A	RR10025S	
S612H2-116L	2-1/16"	Deep	3.27 (83)	3.39 (86)	1.34 (34)	5.51 (140)	A	RR10025S	
S612H2-18L	2-1/8"	Deep	3.39 (86)	3.39 (86)	1.46 (37)	5.51 (140)	B	RR10025S	
S612H2-316L	2-3/16"	Deep	3.46 (88)	3.39 (86)	1.46 (37)	5.51 (140)	C	RR10025S	
S612H2-14L	2-1/4"	Deep	3.54 (90)	3.39 (86)	1.54 (39)	5.91 (150)	C	RR10025S	
S612H2-516L	2-5/16"	Deep	3.66 (93)	3.39 (86)	1.54 (39)	5.91 (150)	C	RR10025S	
S612H2-38L	2-3/8"	Deep	3.7 (94)	3.39 (86)	1.54 (39)	5.91 (150)	C	RR10025S	
S612H2-716L	2-7/16"	Deep	3.78 (96)	3.39 (86)	1.65 (42)	5.91 (150)	C	RR10025S	
S612H2-12L	2-1/2"	Deep	3.86 (98)	3.39 (86)	1.65 (42)	5.91 (150)	C	RR10025S	
S612H2-916L	2-9/16"	Deep	3.94 (100)	3.39 (86)	1.65 (42)	5.91 (150)	C	RR10025S	

6-PT								Retaining Ring
Part Number	Output Size	Description	D1 in (mm)	D2 in (mm)	T in (mm)	L in (mm)	Type	
S612H2-58L	2-5/8"	Deep	4.02 (102)	3.39 (86)	1.81 (46)	5.91 (150)	C	RR10025S
S612H2-1116L	2-11/16"	Deep	4.09 (104)	3.39 (86)	1.81 (46)	5.91 (150)	C	RR10025S
S612H2-34L	2-3/4"	Deep	4.17 (106)	3.39 (86)	1.81 (46)	6.3 (160)	C	RR10025S
S612H1-78	1-7/8"	Standard	3.07 (78)	3.39 (86)	1.26 (32)	3.43 (87)	A	RR10025S
S612H1-1516	1-15/16"	Standard	3.15 (80)	3.39 (86)	1.26 (32)	3.43 (87)	A	RR10025S
S612H2	2"	Standard	3.23 (82)	3.39 (86)	1.26 (32)	3.43 (87)	A	RR10025S
S612H2-116	2-1/16"	Standard	3.27 (83)	3.39 (86)	1.34 (34)	3.43 (87)	A	RR10025S
S612H2-18	2-1/8"	Standard	3.39 (86)	3.39 (86)	1.46 (37)	3.54 (90)	B	RR10025S
S612H2-316	2-3/16"	Standard	3.46 (88)	3.39 (86)	1.46 (37)	3.54 (90)	C	RR10025S
S612H2-14	2-1/4"	Standard	3.54 (90)	3.39 (86)	1.54 (39)	3.74 (95)	C	RR10025S
S612H2-516	2-5/16"	Standard	3.66 (93)	3.39 (86)	1.54 (39)	3.74 (95)	C	RR10025S
S612H2-38	2-3/8"	Standard	3.7 (94)	3.39 (86)	1.54 (39)	3.74 (95)	C	RR10025S
S612H2-716	2-7/16"	Standard	3.78 (96)	3.39 (86)	1.65 (42)	3.94 (100)	C	RR10025S
S612H2-12	2-1/2"	Standard	3.86 (98)	3.39 (86)	1.65 (42)	3.94 (100)	C	RR10025S
S612H2-916	2-9/16"	Standard	3.94 (100)	3.39 (86)	1.65 (42)	3.94 (100)	C	RR10025S
S612H2-58	2-5/8"	Standard	4.02 (102)	3.39 (86)	1.81 (46)	4.13 (105)	C	RR10025S
S612H2-1116	2-11/16"	Standard	4.09 (104)	3.39 (86)	1.81 (46)	4.13 (105)	C	RR10025S
S612H2-34	2-3/4"	Standard	4.17 (106)	3.39 (86)	1.81 (46)	4.13 (105)	C	RR10025S

Accessories

			Retaining Ring
Output Size	Description		
A12F8M	1"	1-1/2" F to 1" M Adapter	RR10025S
A12F20M	2-1/2"	1-1/2" F to 2-1/2" M Adapter	RR10025S
A12F55M	#5 Spline	1-1/2" F to #5 Spline M Adapter	RR10025S
J12	#5 Spline	Universal Joint	RR10025S
E125H	1-1/2"	5" Extension	RR10025S
E1210H	1-1/2"	10" Extension	RR10025S
E1212H	1-1/2"	12" Extension	RR10025S
E1220H	1-1/2"	20" Extension	RR10025S



Universal Joint

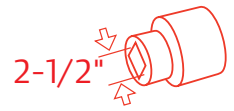

2-1/2" Impact Sockets

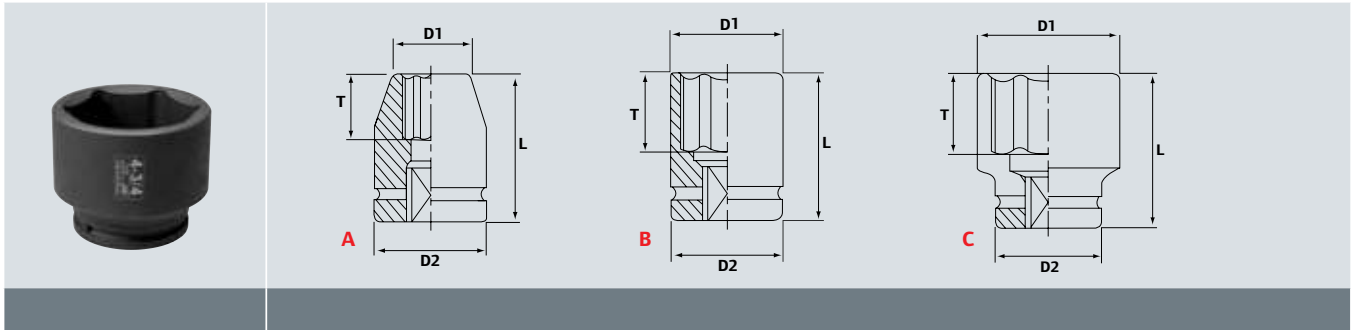

Individuals

6-PT								Retaining Ring
Part Number	Output Size	Description	D1 in (mm)	D2 in (mm)	T in (mm)	L in (mm)	Type	
S620H3	3"	Standard	4.72 (120)	5 (127)	1.77 (45)	5.51 (140)	A	RR10035S
S620H3-18	3-1/8"	Standard	4.88 (124)	5 (127)	1.77 (45)	5.51 (140)	A	RR10035S
S620H3-14	3-1/4"	Standard	5 (127)	5 (127)	1.77 (45)	5.51 (140)	B	RR10035S
S620H3-38	3-3/8"	Standard	5.16 (131)	5 (127)	2.05 (52)	5.51 (140)	C	RR10035S
S620H3-12	3-1/2"	Standard	5.31 (135)	5 (127)	2.05 (52)	5.51 (140)	C	RR10035S
S620H3-58	3-5/8"	Standard	5.47 (139)	5 (127)	2.05 (52)	5.71 (145)	C	RR10035S
S620H3-34	3-3/4"	Standard	5.63 (143)	5 (127)	2.05 (52)	5.71 (145)	C	RR10035S
S620H3-78	3-7/8"	Standard	5.79 (147)	5 (127)	2.28 (58)	5.91 (150)	C	RR10035S
S620H4	4"	Standard	5.94 (151)	5 (127)	2.28 (58)	5.91 (150)	C	RR10035S
S620H4-18	4-1/8"	Standard	6.1 (155)	5 (127)	2.28 (58)	6.1 (155)	C	RR10035S
S620H4-14	4-1/4"	Standard	6.26 (159)	5 (127)	2.36 (60)	6.3 (160)	C	RR10035S
S620H4-38	4-3/8"	Standard	6.42 (163)	5 (127)	2.44 (62)	6.5 (165)	C	RR10035S
S620H4-12	4-1/2"	Standard	6.57 (167)	5 (127)	2.44 (62)	6.5 (165)	C	RR10035S
S620H4-58	4-5/8"	Standard	6.77 (172)	5 (127)	2.64 (67)	6.69 (170)	C	RR10035S

Accessories

			Retaining Ring
Output Size	Description		
A20F12M	1-1/2" 2-1/2" F to 1-1/2" M Adapter		R10035S
E205H	5" Extension		R10035S
E2010H	10" Extension		R10035S
E2020H	20" Extension		R10035S



Extension



#5 Spline Impact Sockets

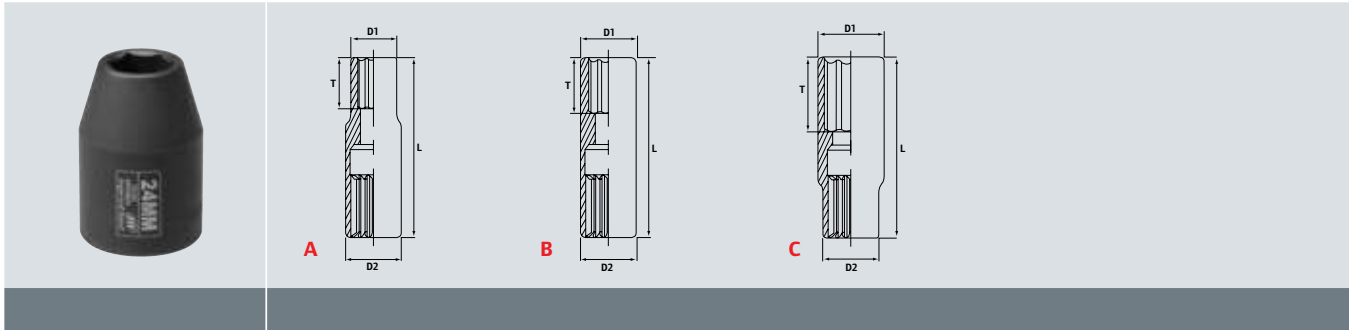

Individuals

6-PT

Part Number	Description	Output Size	D1 in (mm)	D2 in (mm)	T in (mm)	L in (mm)	Type
S65SH1-116	1-1/16"	Standard	1.89 (48)	2.17 (55)	0.94 (24)	3.15 (80)	A
S65SH1-118	1-1/8"	Standard	1.89 (48)	2.17 (55)	0.94 (24)	3.15 (80)	A
S65SH1-114	1-1/4"	Standard	2.17 (55)	2.17 (55)	0.94 (24)	3.15 (80)	B
S65SH1-34	1-3/4"	Standard	2.87 (73)	2.56 (65)	1.5 (38)	3.15 (80)	C
S65SH1-12	1-1/2"	Standard	2.36 (60)	2.17 (55)	0.94 (24)	3.15 (80)	C
S65SH78	7/8"	Standard	1.73 (44)	2.17 (55)	0.94 (24)	3.15 (80)	A
S65SH1516	15/16"	Standard	1.73 (44)	2.17 (55)	0.94 (24)	3.15 (80)	A
S65SH1	1"	Standard	1.81 (46)	2.17 (55)	0.94 (24)	3.15 (80)	A
S65SH1-316	1-3/16"	Standard	2.01 (51)	2.17 (55)	0.94 (24)	3.15 (80)	A

Couplers & Plugs



PR Series

Features

- Made of non-marring composite
- Safety coupler eliminates accidental disconnects
- Easy connect, disconnect
- Allows you to bleed hoses
- Shockproof and crush-resistant
- All couplers/plugs average flow cfm measured at 90 psi inlet and 10 psig pressure drop
- Carbonitride steel with anti-corrosion protection
- Teflon coating on all male threads
- All couplers/plugs average flow cfm measured at 90 psi inlet and 10 psig pressure drop

Female Couplers Male Couplers Hose Barb Couplers



Model	Body Size in		
		NPT	cfm*
FEMALE COUPLERS			
PRSGF22	1/4"	1/4"	32
PRSGF23	1/4"	3/8"	32
PRSGF33	3/8"	3/8"	64
PRSGF34	3/8"	1/2"	64
PRSGF43	1/2"	3/8"	147
PRSGF44	1/2"	1/2"	147
PRSGF46	1/2"	3/4"	147
MALE COUPLERS			
PRSGM22	1/4"	1/4"	32
PRSGM23	1/4"	3/8"	32
PRSGM33	3/8"	3/8"	64
PRSGM34	3/8"	1/2"	64
HOSE BARB COUPLERS			
PRSGH22	1/4"	1/4"	32
PRSGH23	3/8"	1/4"	32
PRSGH33	3/8"	3/8"	64
PRSGH34	1/2"	3/8"	64
PRSGH44	1/2"	1/2"	147
PRSGH45	5/8"	1/2"	147
PRSGH46	3/4"	1/2"	147

*At 90 psig inlet and 10 psig pressure drop.





Female Plugs Male Plugs Hose Barb Plugs



Model	Body Size in	
		NPT
FEMALE PLUGS		
PRPF22	1/4"	1/4"
PRPF23	1/4"	3/8"
PRPF32	3/8"	1/4"
PRPF33	3/8"	3/8"
PRPF44	1/2"	1/2"
FEMALE PLUGS		
PRPM22	1/4"	1/4"
PRPM23	1/4"	3/8"
PRPM32	3/8"	1/4"
PRPM33	3/8"	3/8"
HOSE BARB PLUGS		
PRPH22	1/4"	1/4"
PRPH23	3/8"	1/4"
PRPH33	3/8"	3/8"
PRPH34	1/2"	3/8"
PRPH44	1/2"	1/2"
PRPH45	5/8"	1/2"
PRPH46	3/4"	1/2"



Hoses & Fittings

Whip Hoses



Model					
	NPT Male	NPT Female	in	ft	psig
R00H-130	1/8"	1/4"	1/4"	8'	250
RO-130	1/4"	3/8"	5/16"	8'	250
R1A-130	1/4"	3/8"	3/8"	8'	250
510-130	3/8"	3/8"	3/8"	8'	250



Bulk Hose

Model		Description	
	in		psig
50923	1/4"	1 braid rayon	250
BH6C	3/8"	1 braid rayon	250
BH8A	1/2"	1 braid rayon	250
BH12A	3/4"	1 braid rayon	200

Air Hose Nipples

Model		
	NPT	in (mm)
MALE PIPE THREADS		
A01-46	3/8"	1/2" (13)
A03-46	1/2"	3/4" (19)
AL-387	3/8"	5/16" (8)
D01-14	1/4"	3/8" (10)
D02-455	1/2"	1/2" (13)
IR30127	1/4"	5/16" (8)
IR6225	3/8"	3/8" (10)
IR78217	1/4"	1/4" (6)
J3-581	3/4"	3/4" (19)



Hose Clamps

Model		Description
	in (mm)	
MT1-AL34-3/8	3/8" (10 mm)	1 braid rayon
MT1-AL34-1/2	1/2" (13 mm)	1 braid rayon
MT1-AL34-3/4	3/4" (19 mm)	1 braid rayon
MT1-AL34-1	1" (25 mm)	1 braid rayon



Filters, Regulators & Lubricators

Filters, regulators, lubricators, and piggybacks can be combined together to form combinations. They are typically strung together in the F+R+L arrangement (three-piece combo) and F/R+L (two-piece combo) arrangement, although other configurations are also used depending on application needs. ARO-Flo combination FRLs are easily assembled using modular spacer kits.



2000 Series

NPT	Filter	Components		Lubricator	scfm*	Model
		Regulator				
MANUAL DRAIN • METAL BOWL W/ SIGHT GLASS • RELIEVING • W/ GAUGE						
3/8"	F35331-410	R37331-600		L36331-110	99	C38331-810
1/2"	F35341-410	R37341-600		L36341-110	150	C38341-810
3/4"	F35351-410	R37351-600		L36351-110	171	C38351-810
MANUAL DRAIN • POLYCARBONATE BOWL W/ GUARD • RELIEVING • W/ GAUGE						
3/8"	F35331-400	R37331-600		L36331-100	99	C38331-800
1/2"	F35341-400	R37341-600		L36341-100	150	C38341-800
3/4"	F35351-400	R37351-600		L36351-100	171	C38351-800
AUTO DRAIN • METAL BOWL W/ SIGHT GLASS • RELIEVING • W/ GAUGE						
3/8"	F35331-411	R37331-600		L36331-110	99	C38331-811
1/2"	F35341-411	R37341-600		L36341-110	150	C38341-811
3/4"	F35351-411	R37351-600		L36351-110	171	C38351-811
AUTO DRAIN • POLYCARBONATE BOWL W/ GUARD • RELIEVING • W/ GAUGE						
3/8"	F35331-401	R37331-600		L36331-100	99	C38331-801
1/2"	F35341-401	R37341-600		L36341-100	150	C38341-801
3/4"	F35351-401	R37351-600		L36351-100	171	C38351-801

3000 Series

NPT	Filter	Components		Lubricator	scfm*	Model
		Regulator				
MANUAL DRAIN • METAL BOWLS W/ SIGHT GLASS • RELIEVING • W/ GAUGE						
3/4"	F35451-410	R37451-600		L36451-110	199	C38451-810
1"	F35461-410	R37461-600		L36461-110	215	C38461-810
AUTO DRAIN • METAL BOWLS W/ SIGHT GLASS • RELIEVING • W/ GAUGE						
3/4"	F35451-411	R37451-600		L36451-110	199	C38451-811
1"	F35461-411	R37461-600		L36461-110	215	C38461-811

All technical data for these models can be found at fluids.ingersollrand.com

Spring Balancers

Medium-Duty Short Cable Balancers

- Rugged construction, cast aluminum body
- Stainless-steel cable
- Adjustable capacity
- Safety device against load dropping due to the spring breakage (>3 kg); not available on model BMDS-2
- Adjustable stroke limiting device
- Cable guide in anti-friction material
- Upper suspension shackle included on balancer for ease of installation



BMDS

Medium-Duty Long Cable Balancers

- Rugged construction, cast aluminum body
- Stainless-steel cable
- Adjustable capacity
- Safety device against load dropping due to the spring breakage (>3 kg)
- Adjustable stroke limiting device
- Cable guide in anti-friction material
- Upper suspension shackle included on balancer for ease of installation



BMDLN

Intermediate-duty Balancers

- Safety device prevents load dropping due to spring breakage
- Anti-friction cable guide
- Adjustable stroke limiting device
- Upper rotary suspension
- Safety hook
- Auxiliary safety suspension



BIDS-10

Heavy-duty Balancers

- Safety device prevents load-dropping due to spring breakage
- Upper suspension with rotary safety hook
- Precision guided cable winding prevents jamming
- Anti-friction cable guide
- Manual locking device for instant clamping or release
- Worm screw capacity adjustment
- Spring drum assembly
- Floor controlled locking device available (BIL-7343)



BHD-35

Model	lb (kg)	SWL lb (kg)	ft (m)
BMD SERIES			
BMDS-2	2.2 – 5.5 (1 – 2.5)	4.4 (2)	6.5' (2000)
BMDS-4	4.4 – 8.8 (2 – 4)	4.4 (2)	6.5' (2000)
BMDS-6	8.8 – 13.2 (4 – 6)	5.1 (2.3)	6.5' (2000)
BMDS-8	13.2 – 17.6 (6 – 8)	5.5 (2.5)	6.5' (2000)

BMDL SERIES			
BMDLN-4	4.4 – 8.8 (2 – 4)	6.4 (2.9)	8.2' (2500)
BMDLN-6	8.8 – 13.2 (4 – 6)	7.1 (3.2)	8.2' (2500)
BMDLN-8	13.2 – 17.6 (6 – 8)	7.7 (3.5)	8.2' (2500)
BMDLN-10	17.6 – 22 (8 – 10)	8.2 (3.7)	8.2' (2500)
BMDLN-12	22 – 30 (10 – 13.6)	8.8 (4)	8.2' (2500)

INTERMEDIATE-DUTY BALANCERS			
BIDS-7	8.8 – 15.4 (4 – 7)	5.0 (2.26)	6.5' (2)
BIDS-10	15.4 – 22 (7 – 10)	5.5 (2.49)	6.5' (2)
BIDS-14	22 – 30.8 (10 – 14)	5.5 (2.49)	6.5' (2)
BIDS-18	30.8 – 39.6 (14 – 18)	6.5 (2.95)	6.5' (2)
BIDS-22	39.6 – 48.4 (18 – 22)	6.5 (2.95)	6.5' (2)
BIDS-26	48.4 – 55 (22 – 25)	6.5 (2.95)	6.5' (2)

HEAVY-DUTY BALANCERS			
BHD-15	22 – 33 (10 – 15)	22.7 (10.3)	6.5' (2)
BHD-20	33 – 44 (15 – 20)	23.4 (10.6)	6.5' (2)
BHD-25	44 – 55 (20 – 25)	24.7 (11.2)	6.5' (2)
BHD-30	55 – 66 (25 – 30)	25.4 (11.5)	6.5' (2)
BHD-35	66 – 77 (30 – 35)	26.0 (11.8)	6.5' (2)
BHD-45	77 – 99 (35 – 45)	27.3 (12.4)	6.5' (2)
BHD-55	99 – 121 (45 – 55)	27.6 (12.5)	6.5' (2)
BHD-65	121 – 143 (55 – 65)	30.0 (13.6)	6.5' (2)



Ingersoll Rand (NYSE:IR) advances the quality of life by creating comfortable, sustainable and efficient environments. Our people and our family of brands—including Club Car®, Ingersoll Rand®, Thermo King® and Trane®—work together to enhance the quality and comfort of air in homes and buildings; transport and protect food and perishables; and increase industrial productivity and efficiency. We are a \$13 billion global business committed to a world of sustainable progress and enduring results.



ingersollrand.com